

UNCLASSIFIED

AD NUMBER

AD509705

CLASSIFICATION CHANGES

TO: unclassified

FROM: confidential

LIMITATION CHANGES

TO:

Approved for public release, distribution unlimited

FROM:

Distribution authorized to DoD only; Administrative and Operational Use; May 1970. Other requests shall be referred to the Assistant Chief of Staff for Force Development [Army], Washington, DC 20310.

AUTHORITY

AGO D/A ltr 23 Jan 1976; AGO D/A ltr 23 Jan 1976

THIS PAGE IS UNCLASSIFIED

UNCLASSIFIED

AD_ 509705.

**CLASSIFICATION CHANGED
TO: UNCLASSIFIED -
FROM: CONFIDENTIAL -
AUTHORITY:**

AGC, D/A Hr 23 JAN 76

UNCLASSIFIED

THIS REPORT HAS BEEN DELIMITED
AND CLEARED FOR PUBLIC RELEASE
UNDER LOJ DIRECTIVE 5200.20 AND
NO RESTRICTIONS ARE IMPOSED UPON
I 'S USE AND DISCLOSURE.

DISTRIBUTION STATEMENT A

APPROVED FOR PUBLIC RELEASE;
DISTRIBUTION UNLIMITED.

SECURITY

MARKING

The classified or limited status of this report applies to each page, unless otherwise marked.

Separate page printouts MUST be marked accordingly.

THIS DOCUMENT CONTAINS INFORMATION AFFECTING THE NATIONAL DEFENSE OF THE UNITED STATES WITHIN THE MEANING OF THE ESPIONAGE LAWS, TITLE 18, U.S.C., SECTIONS 793 AND 794. THE TRANSMISSION OR THE REVELATION OF ITS CONTENTS IN ANY MANNER TO AN UNAUTHORIZED PERSON IS PROHIBITED BY LAW.

NOTICE: When government or other drawings, specifications or other data are used for any purpose other than in connection with a definitely related government procurement operation, the U.S. Government thereby incurs no responsibility, nor any obligation whatsoever; and the fact that the Government may have formulated, furnished, or in any way supplied the said drawings, specifications, or other data is not to be regarded by implication or otherwise as in any manner licensing the holder or any other person or corporation, or conveying any rights or permission to manufacture, use or sell any patented invention that may in any way be related thereto.



~~CONFIDENTIAL~~

DEPARTMENT OF THE ARMY
OFFICE OF THE ADJUTANT GENERAL
WASHINGTON, D.C. 20310

UNCLASSIFIED

IN REPLY REFER TO

AGDA (M) (14 May 70)

FOR OT UT 701223

27 May 1970

SUBJECT: Operational Report - Lessons Learned, Headquarters, 25th Infantry Division, Period Ending 31 January 1970 (U)

AD 509705

SEE DISTRIBUTION

1. Subject report is forwarded for review and evaluation in accordance with paragraph 4b, AR 525-15. Evaluations and corrective actions should be reported to ACSFOR OT UT, Operational Reports Branch, within 90 days of receipt of covering letter.

2. Information contained in this report is provided to insure appropriate benefits in the future from lessons learned during current operations and may be adapted for use in developing training material.

BY ORDER OF THE SECRETARY OF THE ARMY:

KENNETH G. WICKHAM
Major General, USA
The Adjutant General

1 Incl
as

DISTRIBUTION:

Commanding Generals

- US Continental Army Command
- US Army Combat Developments Command
- US Army Materiel Command

Commandants

- US Army War College
- US Army Command and General Staff College
- US Army Air Defense School
- US Army Armor School
- US Army Aviation School
- US Army Chemical School
- US Army Civil Affairs School
- US Army Combat Surveillance School
- US Army Electronic Warfare School
- US Army Engineer School
- US Army Field Artillery School

Regraded unclassified when separated
from classified inclosure.

~~CONFIDENTIAL~~

Best Available Copy

UNCLASSIFIED

200503 22 358

~~CONFIDENTIAL~~

DISTRIBUTION (Cont'd)

US Army Infantry School
US Army Institute for Military Assistance
US Army Missile and Munitions School
US Army Ordnance School
US Army Transportation School

Copies furnished:

Office, Chief of Staff, US Army
Deputy Chiefs of Staff
Chief of Research and Development
Assistant Chiefs of Staff
Chief of Engineers
The Surgeon General
Chief of Military History
The Provost Marshal General
OSD(SA) Assistant for Southeast Asia Forces
Director, Defense Research & Engineering
Office, Joint Chiefs of Staff
Commanding Generals
 III Corps, ATTN: Project MASSTER
 25th Infantry Division
Commandant of the Marine Corps
The Air University Library
Director, Weapons Systems Evaluation Group
Defense Documentation Center
USAF Project RAND
Commanding Officers
 US Army Limited War Laboratory
 US Army Logistics, Doctrine Systems & Readiness Agency
 US Army Mobility Equipment Research & Development Center

~~CONFIDENTIAL~~

UNCLASSIFIED

Best Available Copy

CONFIDENTIAL

25TH INFANTRY DIVISION
OPERATIONAL REPORT - LESSONS LEARNED
1 November 1969 - 31 January 1970

CONTENTS

1. Operations: Significant Activities

a. General	Page	1
b. Personnel	Page	50
c. Intelligence	Page	51
d. Operations	Page	55
e. Logistics	Page	69
f. Communications	Page	75
g. Materiel	Page	77
h. Revolutionary Development/Pacification	Page	78
i. Civic Action	Page	79
j. Psychological Operations	Page	80

2. Lessons Learned: Commander's Observations, Evaluation and Recommendations

a. Personnel	Page	80
b. Intelligence	Page	80
c. Operations	Page	84
d. Organisation	Page	91
e. Training	Page	92
f. Logistics	Page	93
g. Communications	Page	96
h. Materiel	Page	96
i. Other	Page	96

Regraded unclassified when separated
from classified inclosure.

CONFIDENTIAL

CONFIDENTIAL

DEPARTMENT OF THE ARMY
HEADQUARTERS, 25TH INFANTRY DIVISION
AFO San Francisco 96225

AVDCMH

1 February 1970

SUBJECT: Operational Report - Lessons Learned, 25th Infantry Division,
Period Ending 31 January 1970, RCS CSFOR - 65 (R2)

SEE DISTRIBUTION

Location: Cu Chi Base Camp (XT647153), Cu Chi, RVN.
Reporting Officer: Major General Harris W. Hollis.
Prepared By: Major Ralph J. Ballway, 18th Military History Detachment.
Map References: Vietnam, 1:50,000, Series: L7014, Sheets: 6131 I, II;
6132 II; 6229 I; 6230 I, II, III, IV; 6231 I, II, III, IV; 6232 II, III,
IV; 6329 IV; 6330 I, II, III, IV; 6331 III.

1. (C) OPERATIONS: Significant Activities.

a. General: During the previous quarter the 25th Infantry Division and the 3rd Brigade, 9th Infantry Division were successful in reaching their proposed objectives. Through the employment of small unit tactics, comprehensive use of electronic surveillance, snipers and combat patrols and the timely pursuit of targets developed from intelligence information, every enemy plan was preempted and 3847 of his soldiers killed. Through combined operations, training and close coordination, South Vietnamese soldiers were assisted to undertake a larger role in the defense of their homeland. The pacification program had continued to expand and to strengthen the bonds between the Vietnamese people and their government. The failure of the enemy to launch a significant coordinated offensive during the quarter attested to the success of these programs.

The 1st Brigade had preempted all enemy attempts to initiate an offensive on Tay Ninh City, worn down the enemy units around Nui Ba Den mountain and south-southwest of the City, and invaded enemy rear areas in the Boi Loi Woods. Of particular significance during the period in the 1st Brigade area was the naval patrol of the Vam Co Dong River. Navy forces operating from Ben Meo (XT2343) and Co Dau Ha (XT382250) effectively restricted enemy infiltration of men and supplies into Tay Ninh from Cambodia.

The 2nd Brigade (and 1st Brigade units operating in the Boi Loi Woods) had contributed significantly to the collapse and destruction of Sub-Region 1 as an effective military and political force. Combat power of Free World

FOR OT UT
701223
Inclosure

CONFIDENTIAL

1

DOWNGRADED AT 3 YEAR INTERVALS;
DECLASSIFIED AFTER 12 YEARS.
DOD DIR 5200.10

CONFIDENTIAL

forces increased significantly in the 2nd Brigade AO due to the heavier concentration of forces in a smaller area of operation and insertion of the 49th ARVN Regiment at Trung Lap. The increased combat power within the 2nd Brigade coupled with the increase in combined operations limited the enemy's use of his traditional base camp areas in the "Citadel" and Ho Bo Woods. During the period, the VC/NVA were forced repeatedly to disperse which rendered them incapable of conducting coordinated offensive operations. The dispersion of main force units allowed the 2nd Brigade to intensify its efforts against Cu Chi and Trang Bang District local force units and the Viet Cong Infrastructure resulting in the rapid deterioration of these enemy forces. Additionally, the 2nd Brigade became increasingly adept at developing highly perishable intelligence information, evaluating it at the local level and reacting immediately for maximum exploitation.

The 3rd Brigade restricted the use by Sub-Region 2 units of the infiltration corridors leading into their area of operations, blocked movement across the Cambodian border, and undermined the local force logistics and communications structure which the main force units remaining in Cambodia had planned to use as a base to launch attacks. An example of the 3rd Brigade's small unit operations was the neutralization of the Hau Nghia City Company, a local Viet Cong force. Quick reaction to intelligence and coordinated psychological operations directed at individual VC and VC elements completely eliminated the unit as a fighting force.

The small unit tactics of the 3rd Brigade, 9th Infantry Division, accounted for 1201 enemy KIA, effectively disrupting Sub-Region 6's efforts to stage for attacks against Saigon in Long An Province and prevented Sub-Region 3 forces from reinforcing its local infrastructure. The 3/9 Inf also killed or captured many prominent Viet Cong personalities and furthered the pacification program in their area of operations. Sniper teams, combat patrols and operations along canals and rivers prevented the enemy from replacing his losses, resupplying his soldiers and gaining political objectives.

Prisoner-of-war interrogations and the large number of Hoi Chanh, in the previous reporting period, indicated the low morale of the enemy. This was due primarily to the relentless pursuit and destruction of enemy units, and enemy inability to resupply his units or evacuate his wounded due to denial operations and population and resources control measures. The enemy had continued to sustain heavy casualties, was driven from many of his "secure" areas and was critically short of food and supplies. Preemption through saturation surveillance, reconnaissance and immediate reaction of massed fires had dealt the Communist insurgency in Tay Ninh, Hau Nghia and Long An Provinces another one-sided defeat.

As this reporting period began, reports indicated that the enemy was

CONFIDENTIAL

preparing for a Winter/Spring Campaign. The Summer and Fall Campaigns had failed miserably to achieve even the slightest advantages for the enemy. COSVN directives continued to maintain the posture that immediate, total victory would result. Enemy efforts during the Winter/Spring Campaign would be directed at wearing down the American desire to continue the war, conducting offensive operations to coincide with and reinforce the anti-war moratoriums in the United States, inflicting heavy casualties on American and allied forces while keeping his own losses to a minimum. Particular emphasis was to be placed toward disruption of the pacification effort and annihilation of Revolutionary Development Cadre.

Beginning this quarter (010001 November 1969), the 25th Infantry Division entered Phase IV of Operation TOAN THANG in Tay Ninh, Hau Nghia and Long An Provinces. Planning guidance stressed operations designed to preempt enemy initiatives, interdiction of main force movement, destruction of local force units, capturing/destroying enemy supplies and disruption of his logistical activities, and exploitation of intelligence from Hoi Chanh and prisoners-of-war with raid or airmobile operations. Emphasis was placed on pacification activities within the TAOI's, concentrating particularly on the upgrading of contested and VC villages to include required operations necessary to upgrade security; preparation to counter interdiction of the MSR networks; continuance of upgrading LOC's in assigned TAOI's; execution of Operation "Look" on order; review and updating of all contingency plans; conducting Traffic Control Points (TCP) in conjunction with Navy elements in assigned TAOI's where applicable; continuing "Overwatch" responsibility to include inspections on assigned bridges, and preparing to support Ranger operations within respective TAOI's.

To counter the enemy's dispersed formations, the Division maneuver elements targeted small groups with the increased use of small unit day and night operations, and employed small maneuver elements (platoons and reinforced squads) oriented towards preempting and destroying the enemy rather than mere reaction to his activity. Continued emphasis was placed upon preparation to reinforce when a contact was established. Planning guidance also called for increased night operations and soliciting ARVN, PF/RF participation in these night operations.

The 1st Brigade operated in Tay Ninh Province with five battalions and was responsible for security on Highways 22 and 26, for combined operations with South Vietnamese units around Tay Ninh City and for coverage of the area around Nui Ba Den. The 1st Brigade was given the mission of conducting day and night operations to locate and annihilate enemy main force and local force units in its TAOI; continuing offensive operations in support of Phase I of the Tay Ninh Defense Plan; preparing to react to enemy threats to Tay Ninh City, and reinforcing RF/PF or ARVN Airborne contacts within the city and destroying enemy elements within the city; conducting dawn and dusk patrols and armed surveillance within the TAOI; planning for and conducting VCI operations in conjunction with GVN forces

CONFIDENTIAL

in Phu Khuong, Hieu Thien, Phuoc Ninh and Khiem Hanh Districts; preparing to react to activity on the road in the vicinity of An Thuan (XT2824); conducting combined operations with the ARVNs, encouraging them to conduct small unit operations and establishing a goal of one-third of the total operations to be conducted during non-daylight hours.

The 1st Brigade was composed of the 4th Battalion, 9th Infantry; the 2nd Battalion (Mechanized), 22nd Infantry; the 3rd Battalion, 22nd Infantry; the 4th Battalion (Mechanized), 23rd Infantry and the 2nd Battalion, 34th Armor. The 1st Brigade was supported by the 7th Battalion, 11th Artillery. Enemy units in the 1st Brigade area were the D1 Battalion; the D14 Battalion; the 271 VC/NVA Regiment; the 272 VC/NVA Regiment; the 95C Regiment and the 88 NVA Regiment.

The 2nd Brigade operated with three battalions and one cavalry squadron conducting extensive combat patrol, ground and mounted reconnaissance, and combat assault operations in the central portion of the Division TAOI and conducted security along sections of Highways 6A, 7A, 8A, 19, 15 and 1. The 2nd Brigade was directed to conduct offensive Mechanized/Infantry, air-mobile operations and combined operations with the 5th ARVN Division in the Ho Bo Woods and Filhol Rubber Plantation area and with the 25th ARVN Division in the Citadel and Trung Lap areas, with emphasis on small unit operations and destruction of SR-1 and local force units; conduct offensive operations to counter enemy interdiction of MSRs; continue VCI and military pacification and consolidation operations in conjunction with GVN forces in Trang Bang and Cu Chi Districts; encourage GVN forces to conduct small unit operations, establishing a goal of one-third of GVN forces on night operations, and be prepared to secure, support and control Rome Plow operations in the Brigade TAOI;

The 2nd Brigade's maneuver battalions were the 2nd Battalion, 12th Infantry; 2nd Battalion, 14th Infantry; 1st Battalion (Mechanized), 5th Infantry and 3rd Squadron, 4th Cavalry (-). The 2nd Brigade was supported by the 1st Battalion, 8th Artillery. Enemy units in the 2nd Brigade's area included the 101 NVA Regiment; the 268 VC/NVA Regiment; the 1st Quyet Thang Battalion and the 2nd Quyet Thang Battalion.

The 3rd Brigade's two maneuver battalions operated in the southern portion of Hau Nghia Province with responsibility for road security along sections of Highways 7A, 8A and 9A and the pacification program in the Bao Trai area where the Brigade's forward headquarters was located. The 3rd Brigade was directed to conduct combined operations with the 25th ARVN Division emphasizing small unit tactics and night operations; conduct VCI, military pacification and consolidation operations in Duc Hoa and Duc Hue Districts; establish periodic patrol bases in Phuoc Luu area and/or the Plain of Reeds; initiate combined operations with local PF/RF forces stressing night operations; coordinate with Duc Hue and Tra Cu CIDG to conduct joint operations with the USN along the Vam Co Dong river to in-

CONFIDENTIAL

clude combined company-sized Eagle Float operations.

The 3rd Brigade's maneuver battalions were the 1st Battalion, 27th Infantry and the 2nd Battalion, 27th Infantry. Support was provided by the 2nd Battalion, 77th Artillery. Enemy units within the 3rd Brigade area were the 267 Battalion; 269 Battalion; 2642 Battalion; D16 Battalion; 308 Battalion and the 6 Local Force Battalion.

The 3rd Brigade, 9th Infantry Division operated with four battalions in the Long An Province area with responsibility for the security of Highways 4, 18 and 23 and for the local pacification program. Planning guidance for the 3rd Brigade, 9th Infantry Division emphasized conducting extensive combined operations with Long An ARVN and PF/RF units using small unit tactics and night operations; conducting VCI and military pacification and consolidation operations in Long An Province; conducting Bushmaster, checkerboard and airmobile operations to detect and destroy enemy infiltration; continuing overwatch responsibility on MSRs and bridges within the TAOI, and coordinating with the USN to conduct riverine/Eagle Float operations within the TAOI.

The 3rd Brigade, 9th Infantry Division's maneuver battalions were the 6th Battalion, 31st Infantry; the 2nd Battalion (Mechanized), 47th Infantry; the 2nd Battalion, 60th Infantry and the 5th Battalion, 60th Infantry. The Brigade was supported by 2nd Battalion, 4th Artillery. Major enemy units in Long An Province were 1 NVA Regiment; 506 Battalion; 508 Battalion; 520 Battalion; 265 Battalion; Dong Phu Battalion; N10 Battalion; N13 Battalion; N14 Battalion; N16 Battalion; N18 Artillery Company and N19 Company. (See Overlay 1 - Enemy Situation)

During the first week of November (1-7 November) there was a marked increase in friendly initiated contacts as US troops continued to preempt enemy activities, disrupt his lines of communications and supply, and seek out and destroy his "secure" areas. Enemy initiated contacts continued at a low level, and can be attributed to the reduced flow of logistics and replacement personnel to VC/NVA units within the Division's TAOI.

Tran Minh Dao, former Senior Captain of SR-1, has been very helpful to the 25th Infantry Division in analyzing the VC/NVA activities within Sub-Region 1. The following are Dao's opinions on the low level of VC/NVA activity which can be attributed to both military and political reasons. Military problems have stemmed from difficulty encountered in transportation of all types of supplies, the high rate of local guerrilla casualties, the increased number of Hoi Chanh, and SR-1 units being deprived of local guerrillas for guides and reconnaissance. Dao feels that politically, the low level of action is planned to coincide with the recent "Moratorium Day" and that increased military operations by the VC/NVA would most likely have an adverse effect on the VC/NVA political position. However, Dao also believes that during November and December there will be a slight

CONFIDENTIAL

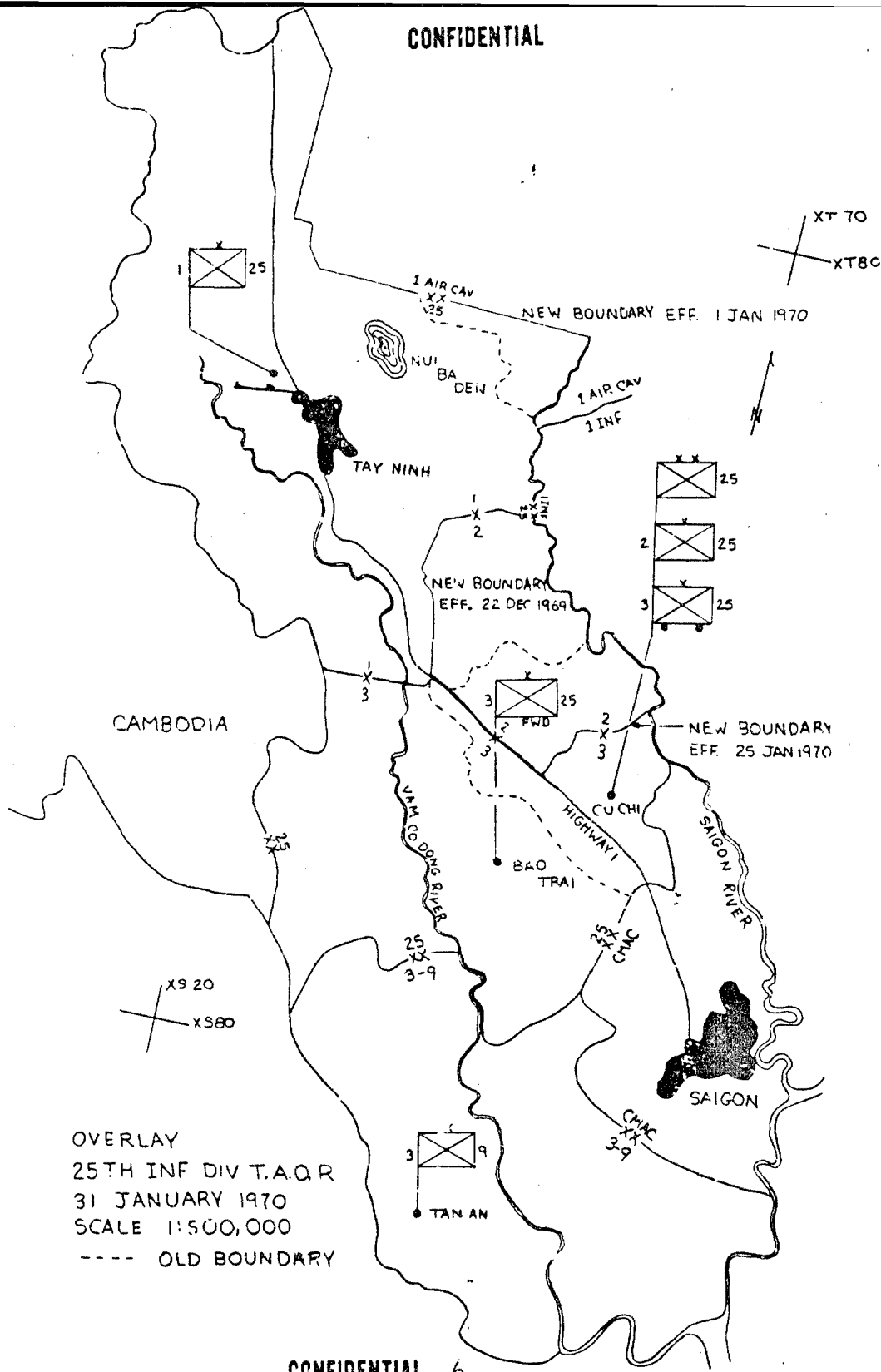

OVERLAY
 25TH INF DIV T.A.Q.R
 31 JANUARY 1970
 SCALE 1:500,000
 ---- OLD BOUNDARY

CONFIDENTIAL 6

CONFIDENTIAL

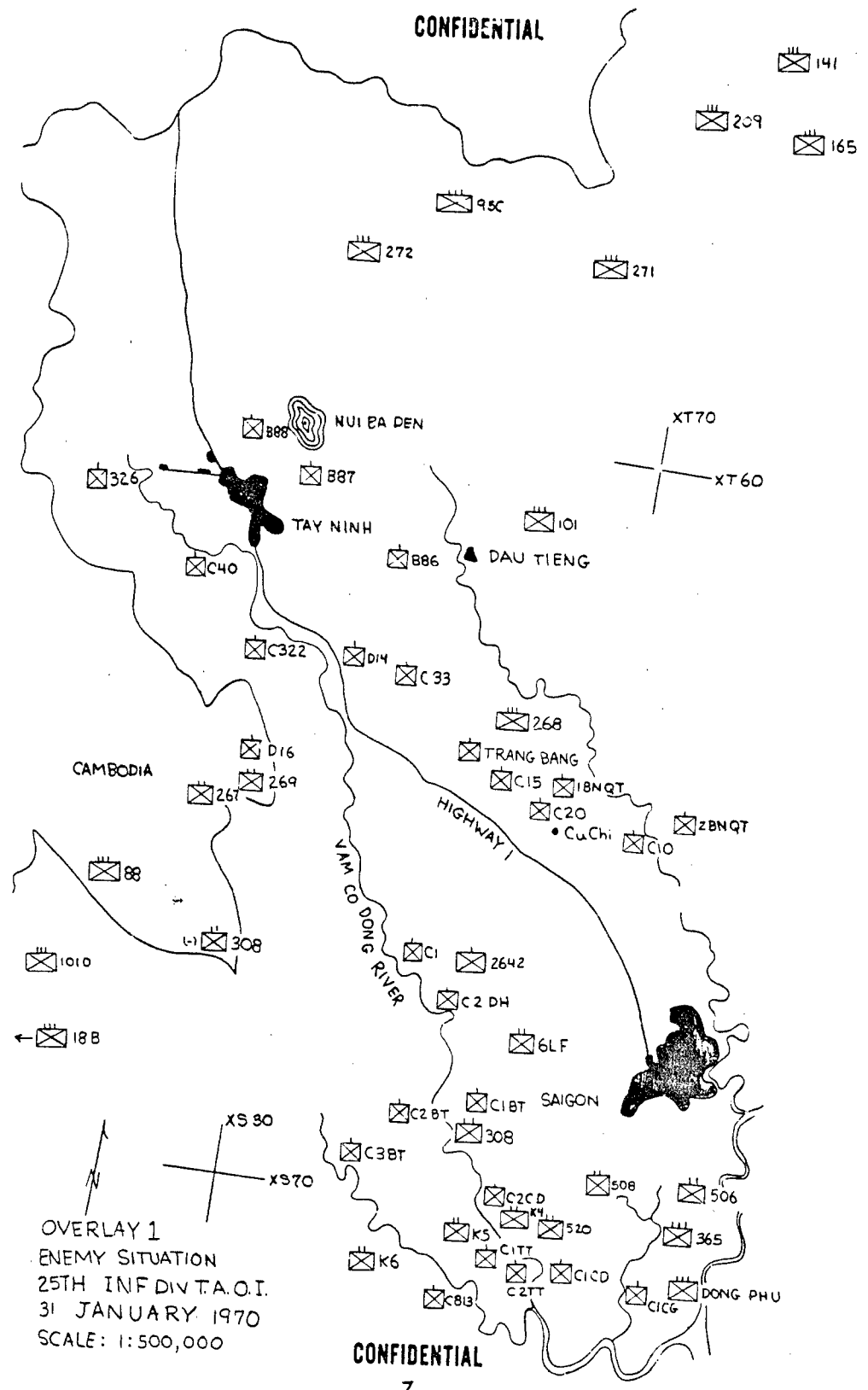

OVERLAY 1
 ENEMY SITUATION
 25TH INF DIV T.A.O.I.
 31 JANUARY 1970
 SCALE: 1:500,000

CONFIDENTIAL

CONFIDENTIAL

increase in activity throughout SR-1. This probable increase may be attributed to several reasons: to agitate anti-war sentiment in the United States, to support the VC/NVA political position at the Paris Peace Talks, and to show that the VC/NVA are still capable of launching offensive actions. Most of the efforts during the upcoming phase should be directed against the GVN Pacification Program, specifically Revolutionary Development Cadre. Dao also indicated that even though both the Quyet Thang Battalions and the 268 Regiment have received sapper training, they have been unable to launch any offensive actions because of increased US/ARVN activities throughout SR-1. In addition, Dao blamed the lack of rocket attacks to the critical resupply situation in SR-1, and does not feel that it has anything to do with a change of tactics.

In the 1st Brigade area of operations, Company B (-), 4th Battalion (Mechanized), 23rd Infantry, while conducting a dismounted reconnaissance of an intelligence target on the morning of 2 November (1110 hours), engaged an unknown number of enemy three kilometers northeast of Cau Khoi (XT362-481) with small arms, automatic weapons, light fire team and artillery resulting in three enemy soldiers being killed. The engagement was initiated when the Battalion C&C ship spotted movement in a bunker complex to the front of Company B (-). The enemy returned fire with small arms and automatic weapons wounding one US soldier and causing minor damage to a LOH. At dawn on 3 November, Company A, 3rd Battalion, 22nd Infantry in a sweep of this area located bodies of 12 enemy soldiers who had been killed in the previous day's action with B/4-23 Inf (M), bringing the number of enemy killed to 15.

In order to preempt enemy infiltration from the upper "Angel's Wing" (XT2525) through the Renegade Woods (XT2832), the 4th Battalion, 9th Infantry established numerous combat patrols in the area of the Renegade Woods to the Vam Co Dong river. On the evening of 2 November (2130 hours), a combat patrol from Company C operating four kilometers east of the Renegade Woods (XT352308) engaged an estimated enemy platoon with small arms, automatic weapons and helicopter gunships. The enemy returned fire with small arms, automatic weapons and RPGs. Three of the enemy were killed. Three hours later (0145 hours on 3 November) a combat patrol from Company B engaged seven enemy 10-25 meters east of their position on the north-western edge of the Renegade Woods (XT264324) with small arms and automatic weapons killing three of the enemy. At 0403 hours a combat patrol from Company D operating 400 meters south of the Renegade Woods (XT296275) engaged two enemy 20 meters from their position moving south with small arms and automatic weapons, killing both of the enemy soldiers. The US troops evacuated one AK-47 rifle and 1/2 pound of documents which identified the 268 Regiment but contained no tactical information.

During the first week of November Tay Ninh Base Camp (XT1652) experienced an increase in shelling incidents. At 0935 hours on 4 November the base received three 122mm rockets. On the evening of 5 November (1900 hours) the base received three more 122mm rockets, destroying 1400 powder

CONFIDENTIAL

CONFIDENTIAL

charges (800 8", 300 175mm, 300 155mm). At 0650 hours on the morning of 7 November Tay Ninh Base Camp received four 122mm rockets causing light damage to one AH1G and two UH1H's, and moderate damage to one AH1G.

The most significant contacts during the first week of November occurred in the Citadel and Ho Bo Woods in the 2nd Brigade area of operations. On 1 November at 0820 hours gunships from the 116 Assault Helicopter Company with elements of the 2nd Battalion, 14th Infantry engaged seven enemy six kilometers southwest of Ben Suc (XT517315) with automatic weapons killing all seven of the enemy.

Three kilometers southwest of Ben Suc (XT555306) Raiders of the 3rd Platoon, Troop A, 3rd Squadron, 4th Cavalry engaged three enemy hiding inside a large bunker with small arms and automatic weapons, killing two of the enemy and capturing the third. Upon interrogation of the prisoner-of-war it was discovered that all three of the enemy had been high ranking officers in the B-6 Section of the Rear Service Staff of SR-1. Searching the bunker, the Raiders discovered 2,125,000 piasters (US \$18,000) which was to be used to buy 500,000 liters of rice for the month of November. The B-6 Section had the mission of making supplies and equipment available to SR-1 units and of supplying the Rear Service Groups.

A readout of documents following a light contact initiated by Troop A, 3-4 Cav on 2 November three kilometers southwest of Ben Suc (XT555306) provided additional evidence of the seriousness of rice shortages in Sub-Region 1. A letter between two rear service cadre dated 25 October stated in part, "The situation in this area is extremely tense, since practically every unit down here has been stricken by hunger. Clinging to the Ben Chua area (XT555358) to purchase rice is a matter of life or death for all units." A notebook entry dated 28 October stated that medical and food problems had remained unsolved during the Fall Campaign and were not likely to be solved during the forthcoming Winter Campaign. The entry reaffirmed that objectives would be attacked only by sapper and artillery elements during this campaign, and stated that efforts must be made to frustrate allied population resettlement measures in Ben Cat and Trang Bang Districts.

Information gained on 3 November from two prisoners-of-war revealed that because of Rome Plow operations in the Boi Loi Woods (XT5333) and increased allied operations in the Boi Loi Woods and south of the "Mushroom" (XT5830) it has become necessary for enemy support elements (Rear Service Section of SR-1 and 83 Rear Service Group) to shift many of their resupply activities across the Saigon River (XT6531-XT6630).

Initial readout of a notebook captured northeast of Trung Lap (XT625-253) revealed that the 268 Regiment was to conduct attacks on a number of allied positions during the opening of the 1969 Winter Campaign. An entry dated 27 October 1969, consisting of notes taken at a regimental combat planning meeting, disclosed that the Regiment's primary objectives

CONFIDENTIAL

would be allied installations in the Cu Chi area, including artillery positions near Lao Ta (vicinity XT655195) and a "Blocking Position" in the Soui Sau area (XT543177), a probable reference to FSB Devins. The document stated that the purpose of the campaign would be to apply pressure against the United States government for an immediate withdrawal of US troops from South Vietnam.

While carrying out a ground reconnaissance mission on 4 November in the Citadel, Company D, 2nd Battalion, 14th Infantry located nine NVA bodies in graves (48 hours old) three kilometers northwest of Trung Lap (XT567236) who had been killed by artillery.

A three-company operation of the 2nd Battalion, 12th Infantry on the morning of 5 November resulted in 26 NVA KIA. Companies A and C had been airlifted to the Troop C, 3rd Squadron, 4th Cavalry night defensive position (XT539294) on the evening of 4 November. Company B moved from Fire Support Base Pershing (XT518256) to a holding area (XT537265). By 0300 hours on 5 November the three companies had moved from their respective holding areas and formed a cordon around the objective area (XT5528). The objective was a much used R&R center for enemy troops based in the Boi Loi and Ho Bo Woods. Seven ambush sites were established to engage any enemy exfiltrating from the objective area. At 0445 hours three light fire teams began to engage the objective area which had been illuminated by two UH1H flareships and one AC-47 flareship. It was following this initial engagement that enemy soldiers began exfiltrating the area and ran into the 2-12 Inf ambushes. At first light the three companies moved into the objective area to search it. The results of this cordon and search were very rewarding. Twenty-six enemy soldiers had been killed and two prisoners-of-war captured, US troops evacuated six AK-47 rifles, two K-54 pistols and six pounds of documents. No US casualties were sustained during this operation. Initial interrogation of one of the two prisoners-of-war indicated that his unit was a rice transportation platoon of the 268 Regiment.

At 1850 hours on the evening of 6 November, a combat patrol from Company A, 2nd Battalion, 14th Infantry, located at the junction of Highways 7A and 15 (XT655257), engaged 20 enemy (estimated) with small arms, automatic weapons, a light fire team and one UH1H flareship. Artillery support was provided by Battery A, 1st Battalion, 8th Artillery and Battery A, 3rd Battalion, 13th Artillery (89 rounds). Two US troops were wounded in this contact which resulted in 14 NVA KIA. One AK-47 rifle, one K54 pistol and $\frac{1}{2}$ pound of documents were evacuated.

Enemy activity in the 3rd Brigade area of operations continued at a low level as the 1st and 2nd Battalions, 27th Infantry maintained pressure against enemy elements attempting to infiltrate in the 3rd Brigade's TAOI.

Activity within the 3rd Brigade, 9th Infantry Division's area of operations continued at a steady but low level with 3-9 Inf Div elements continuing

10

CONFIDENTIAL

CONFIDENTIAL

to disrupt enemy lines of communications and destroying the VC infrastructure.

At 1600 hours on 1 November Company A, 5th Battalion, 60th Infantry uncovered a cache three kilometers southwest of the "Pineapple" (XS 7787) in the Bo Bo Canal. The cache contained 90 rounds of 82mm mortar ammunition, 117 82mm mortar boosters and 57 82mm mortar fuses, all of which were destroyed in place. The following morning (2 November) at 0815 hours, A/5-60 Inf reacting to Red Haze readings uncovered another cache located in the brush next to the Bo Bo Canal in the same vicinity (XS47786) as the cache discovered the previous evening. The second cache consisted of 66 82mm mortar charges and 90 82mm mortar fuses and was also destroyed in place.

On 4 November at 2250 hours, a combat patrol from Company D, 2nd Battalion, 60th Infantry, operating three kilometers northeast of Ap Tan Thuan (XS702642), engaged eight enemy with small arms, automatic weapons, artillery and light fire team killing all eight of the enemy and capturing two AK-47 rifles. One US soldier was wounded during the contact.

While operating seven kilometers northeast of My Tho (XS554587), Team 21, Company F, 75th Infantry (Ranger) on the evening of 5 November at 2250 hours engaged 20 enemy with small arms, automatic weapons and artillery killing five NVA soldiers. The enemy returned the fire with small arms and automatic weapons, wounding two of the Rangers. One AK-47 rifle and one RPD light machine gun were evacuated.

The second week of November (8-15 November) showed a change in tactics by the enemy as he prepared for his 1969 Winter Campaign. Within the 25th Infantry Division area of operations there was a marked increase in shelling incidents with very few contacts. But activity did not approach the planned level as the enemy failed to meet his schedule for the beginning of the Winter Campaign. Within the 25th Infantry Division TAOI the enemy continued to have difficulty in feeding his troops, moving munitions and replacing personnel. With no visible assistance from COSVN Main Force regiments it appeared that the planned highpoint would strain the available sub-regional forces to the limit. Those enemy units who were involved in contacts in Sub-Regions 1 and 2 were identified as rear service and support elements. Most of the SR-2 units remained in their Cambodian bases. The most significant contacts during the week occurred in the 3rd Brigade, 9th Infantry Division's area of operations with 87 enemy killed in seven friendly initiated contacts.

Enemy activity continued at a low level with no major changes in the order of battle. Evidence is accumulating that the 95C Regiment has been subordinated to the 9 VC/NVA Division and that the 88 Regiment may no longer be subordinate to the 9 VC/NVA Division. The 88 Regiment is most likely now subordinate to the 1 VC/NVA Division.

During the period 8-15 November there was a total of 23 separate shelling incidents within the 25th Inf Div AO. On the morning of 12 November Tay Ninh Base Camp (XT165515) received six 107mm rockets. At 0120 hours, the

//

CONFIDENTIAL

CONFIDENTIAL

same morning, the base received an additional 20 rounds of 82mm mortar fire, wounding four US soldiers and causing heavy damage to one UH1H and light damage to two UH1Hs. Two days later (14 November) Tay Ninh Base Camp received two 122mm rockets at 1450 hours. Two US soldiers were wounded, one UH1H destroyed, heavy damage was caused to two 1.5 ton trucks and light damage to one AH1G.

A prisoner-of-war captured on 8 November 100 meters outside of the Tay Ninh Base Camp perimeter (XT153525) identified his unit as the 33 Company, which indicated that he may possibly be a member of the 4 Sapper Battalion subordinate to COSVN's 17 Armor Office. He said that his mission was to reconnoiter Tay Ninh for a future attack, date and time unknown. Although he variously claimed he was a private or corporal, he was wearing a pistol, suggesting that he was actually an officer, and during his interrogation, he was very uncooperative and changed his story several times, further suggesting that he was a dedicated cadre member.

Night offensive positions of the 4th Battalion, 9th Infantry received four attacks by fire during the 8-15 November period totalling 31 82mm mortar rounds. On 11 November at 2115 hours, a combat patrol from Company B, 3rd Battalion, 22nd Infantry observed 15 rounds of 82mm mortar fire impacting outside the wire of their night defensive position. There were no Division casualties in either contacts.

On the afternoon of 12 November (1500 hours) an estimated 22 enemy entered Phuc Long, four kilometers east of Nui Ba Den (XT330575), and kidnapped 40 villagers. The enemy was reported to be armed with two RPG launchers and five AK-47 rifles.

In the 2nd Brigade area of operations there were 15 shelling incidents between 8 and 15 November. The 2nd Battalion, 12th Infantry received attacks by fire against Patrol Base Dees (XT554227) and Fire Support Bases Pershing (XT518256) and Jackson (XT425168) which wounded nine US soldiers. The 2nd Battalion, 14th Infantry received attacks by fire against Patrol Base Hunsley (XT596270), Fire Support Base Patton (XT582195) and several night offensive positions resulting in five US soldiers being wounded. A night offensive position of Troop B, 3rd Squadron, 4th Cavalry (XT530328) received nine RPG rounds and 11 82mm mortar rounds at 0119 hours on 12 November resulting in two US being wounded and light damage to one APC.

Documents captured on 14 November in the southern Citadel three kilometers northeast of Trang Bang (XT511211) contained a report dated 13 November which revealed that reconnaissance of US positions in the Lam Vo area (three kilometers northwest of Trung Lap - XT558223) by the C1 Company, 1 Sapper Battalion, 268 Regiment was delayed several days because of the presence of allied troops in the area. This report is the first positive statement that allied operations have preempted enemy activity in Sub-Region 1. The report also revealed that the unit is planning to coordinate attacks with local forces in the area.

12

CONFIDENTIAL

CONFIDENTIAL

Initial interrogation of seven prisoners-of-war captured by Troop B, 3rd Squadron, 4th Cavalry six kilometers west of Ben Suc (XT517347) on 8 November revealed that two of the prisoners were members of the C7 Hospital, another PW was convalescent in the hospital and the remaining four PWs were from the Rear Service Group of SR-1. A member of the security platoon, C7 Hospital and the Executive Officer of the C7 Hospital were captured by the 389 Regional Force Company six kilometers east of Co Dau Ha (XT450248) on 8 November. Further interrogation of the platoon leader of the security guard section revealed that the C7 Hospital had been severely damaged, if not completely destroyed, during recent allied operations in the Bau Man (XT512303) area.

The discovery of two large caches within the 25th Infantry Division TACR resulted in large losses to the enemy of vital supplies and munitions. On 12 November at 0815 hours, Company B, 3rd Battalion, 22nd Infantry discovered and evacuated 84 cases (21,000 rounds) of small arms ammunition from a cache located in a hole eight kilometers south of Dau Tieng (XT505385). On the 15th of November at 1100 hours, Troop A, 3rd Squadron, 4th Cavalry reacting to intelligence information supplied by a Hoi Chanh uncovered a heavy weapons cache located 3.5 kilometers south of Ben Suc (XT579298). Two 60mm mortars (complete), five ChiCom machine guns, five .30 caliber machine guns, one M60 machine gun, 17 K-44 carbines, seven wheel mounts for a light machine gun and 42 cans of .31 caliber brass were evacuated.

The only significant contact in the 3rd Brigade area of operations during the second week of November was on 13 November at 2145 hours when Team 24, Company F, 75th Infantry (Ranger) operating on the Vam Co Dong River two kilometers north of the "Sugar Mill" (XT399133) engaged 10 enemy with small arms and automatic weapons killing all ten of the enemy. One AK-47 rifle, 1 1/2 pound of medical supplies, 1/2 pound of documents and 1 9mm pistol were evacuated. There were no US casualties. Initial readout of the documents mentioned the Duc Hoa District Committee.

In the 3rd Brigade, 9th Infantry Division, US troops continued to seek out and destroy enemy supply and transportation elements, infiltration groups and main and local force units.

In an operation by the Reconnaissance Platoon, 2nd Battalion, 60th Infantry on the afternoon of 11 November following a combat assault 4.5 kilometers northwest of Ap Tan Thuan (XS633655), US troops and helicopter gunships of the 190th Assault Helicopter Company killed 17 enemy in six separate engagements between 1510 and 1625 hours. Two carbines, three AK-47 rifles and one M-16 rifle were evacuated by the US troops.

At 0001 hours on 12 November a combat patrol from Company C, 2nd Battalion (Mechanized), 47th Infantry engaged an unknown number of enemy with small arms, automatic weapons, artillery and mortar fire, 5.5 kilometers southwest of Tan An (XS531595) resulting in four enemy killed. At 0245 hours,

CONFIDENTIAL

CONFIDENTIAL

after relocating the ambush site approximately 150 meters to the southwest (XS530594), the patrol engaged an unknown number of enemy with small arms, automatic weapons, artillery and mortar fire, resulting in 12 more enemy killed. No US casualties were sustained in either contact.

A combat patrol from Company A, 2nd Battalion (Mechanized), 47th Infantry engaged an unknown number of enemy 4.5 kilometers north of Binh Phuoc (XS602596) at 2220 hours on 15 November. The patrol engaged the enemy with small arms and automatic weapons fire killing 11 of the enemy. Documents captured in the contact identified the K6 Battalion, 1 NVA Regiment.

One platoon of Company D, 5th Battalion, 60th Infantry engaged an unknown number of enemy with organic weapons, light fire team, TAC air strikes and artillery following a combat assault seven kilometers northeast of Tan An (XS602692) at 1250 hours on 13 November killing 10 of the enemy. One US soldier was killed. Three hours later (1600 hours), Company C, 5th Battalion, 60th Infantry while conducting a Jitterbug operation in this same area (XS-602692) located 2 NVA KIA and evacuated one AK-47 rifle and $\frac{1}{2}$ pound of documents. Forty-five minutes later (1645 hours) 1.3 kilometers southwest of this location (XS600680), C/5-60 Inf engaged an enemy force with small arms, automatic weapons, helicopter gunships, TAC air strikes and three artillery batteries (447 rounds), resulting in 19 NVA KIA. Four AK-47 rifles and one K-54 pistol were evacuated. One US soldier was wounded during this contact.

While conducting a Jitterbug operation on 14 November, Company A, 2nd Battalion, 60th Infantry with helicopter gunships of the 190th Assault Helicopter Company engaged an unknown number of enemy at 1220 hours 3.5 kilometers northwest of Ar Tar Thuan (XS648637). Twelve enemy were killed by organic weapons and helicopter gunship fires of this force.

A rallier to Tan An Sector on 11 November identified himself as the Commanding Officer of the C314 (C1 Tan Tru) Local Force Company. The Hoi Chanh stated that the majority of the men in the company were NVA. This is the first report that the majority of the personnel in a local force unit were from the North, and if confirmed, would indicate that the enemy is experiencing serious difficulties in his recruiting efforts. A readout of COSVN Resolution Nine does specify that local forces must be strengthened to bear the brunt of the effort against the GVN Pacification effort.

Further indication that SR-3 units are receiving replacements came from interrogation of a prisoner-of-war captured by Long An Sector Forces. The PW stated that he was an assistant platoon leader in the C11 Company, K6 Battalion, 1 NVA Regiment and that he and 20 other men had come from Ba Thu, Cambodia to join the K6 Battalion.

Both enemy activity and friendly initiated incidents decreased during the third week of November (16-22 November). In Sub-Region 1 enemy activity remained moderate with the upper Citadel and lower Boi Loi Woods being the

CONFIDENTIAL

center of activity. Enemy units contacted in SR-1 were generally rear service and support elements. In Sub-Region 2 enemy activity continued at a low level. Intelligence information indicated that the movement of supplies along the Bo Bo Canal and between Ba Thu, Cambodia and the "Sugar Mill" picked up slightly during the week. But, enemy units who usually operate in this area seem reluctant to move out of their Cambodian sanctuaries. Enemy activity increased slightly within Sub-Region 3 but not to a significant level.

Lack of enemy activity during the third week of November can be attributed to a number of reasons. Most of the enemy units remained understrength and supplies did not meet necessary levels for offensive actions. There has been no substantial evidence to demonstrate an increase in the infiltration effort which would be necessary if COSVN intended to carry out its plans for the Winter/Spring Campaign.

Division Intelligence sources indicated that major enemy units may be shifting south to IV Corps, an area they consider more lucrative than III Corps for political as well as military reasons. Enemy units within the 25th Infantry Division TAOI may attempt highpoints and attacks for the Winter/Spring Campaign but organizational and logistical difficulties mentioned will limit their objectives and effectiveness. Tactically, there may be an increase in enemy activity during the last week of the month as this has been prevalent of enemy activities in the prior three months.

Within the 1st Brigade area of operations there was a sharp decline in shelling incidents as compared to the previous week. Only six shelling incidents were reported with no Division casualties. Tay Ninh Base Camp (XT165515) remained the primary target for enemy attacks by fire. At 1920 hours on 17 November 15 rounds of unknown HE fire were observed impacting outside the wire of the base camp. Two days later (19 November) the base received five 107mm rockets at 0610 (two inside, three outside) resulting in light damage to four jeeps. Two days after this attack (21 November) Tay Ninh Base Camp received 15 rounds of 120mm mortar fire at 0008 hours resulting in two buildings destroyed and one building slightly damaged. At 0950 hours that same morning, Company C, 3rd Battalion, 22nd Infantry while conducting a ground reconnaissance evacuated 15 rounds of 120mm mortar ammunition from a cache located at the approximate location (XT176568) from which Tay Ninh Base Camp received the attack by fire earlier that morning.

Company B, 4th Battalion (Mechanized), 23rd Infantry located six NVA killed by artillery at 1335 hours on 17 November three kilometers southwest of the Ben Cui Rubber Plantation (XT419422) while sweeping Highway 239.

Two and one-half kilometers east of Soui Da (XT358567) Team 21, Company F, 75th Infantry (Ranger) at 1820 hours on 18 November engaged an unknown number of enemy with small arms, automatic weapons, one UH-1 flareship,

CONFIDENTIAL

two TAC air strikes and two artillery batteries (40 rounds). The enemy returned with small arms, automatic weapons and M-79 fire killing one US soldier and wounding three others. Seven NVA were killed in the contact.

Activity within the 2nd Brigade area of operations centered around the upper "Citadel" (XT5329) and lower Boi Loi Woods (XT5333) during the third week of November.

At 1400 hours on 16 November, the Scout Platoon, 1st Battalion (Mechanized), 5th Infantry received two Hoi Chanh while conducting a reconnaissance mission five and a half kilometers east of Trang Bang. One of the Hoi Chanh identified himself as a squad leader of the 2 Company of the Trang Bang Local Force Battalion. Exploiting information from one of the Hoi Chanh, Set/1-5 Inf (M) uncovered a cache and evacuated one 60mm mortar (complete), one light machine gun, two AK-47 rifles, one RPG launcher, one M-1 carbine and one pound of documents. They also destroyed two hand grenades, one RPG booster, 50 blasting caps and one AK-47 rifle.

On 20 November at 1240 hours, elements of the 2nd Battalion, 14th Infantry with gunships of the 116th Assault Helicopter Company and an Air Force Forward Air Controller engaged an unknown number of enemy with two light fire teams, three air strikes and two artillery batteries (142 rounds) four kilometers east of Trung Lap (XT624217). The 1-49th ARVNs swept the area of contact and located 17 NVA KIA.

On the evening of 21 November at 2010 hours, a combat patrol from Company D, 2nd Battalion, 12th Infantry operating seven kilometers southwest of Ben Suc (XT308302) engaged an unknown number of enemy with small arms and automatic weapons resulting in seven NVA KIA. US troops evacuated one ChiCom pistol and one US carbine and destroyed two hand grenades. Documents taken from the enemy bodies identified the C7 Military Hospital of the Rear Service Staff of Sub-Region 1.

At 1905 hours on 20 November, a combat patrol from Company A, 2nd Battalion, 14th Infantry located five kilometers northeast of Trung Lap (XT631240) engaged six enemy with organic weapons and artillery killing all six of the enemy. Two days later (22 November) a combat patrol from Company C, 2-14 Inf located three and a half kilometers southeast of Ben Suc (XT596307) engaged 18 enemy with helicopter gunships and artillery resulting in eight NVA KIA.

Snipers of the Combined Reconnaissance Intelligence Platoon (CRIP) of the 2nd Battalion, 14th Infantry killed 14 enemy on the night of 22 November. At 2140 hours a sniper team operating two and a half kilometers north of Trung Lap (XT587245) on the west bank of the Ba Ca Bay stream engaged three enemy at 300 meters with small arms killing all three. At the same time (2140 hours) a second sniper team located 300 meters to the

CONFIDENTIAL

east of the first team (XT590245) and on the east side of the Ba Ca Bay stream engaged seven enemy at 300 meters with small arms fire resulting in six NVA KIA. One and one-half hours later, the first team, after relocating 800 meters to the south (XT589238), engaged ten enemy with small arms fire resulting in five NVA KIA. There were no US casualties sustained in any of the contacts.

At 1010 hours on 21 November, Troop A, 3rd Squadron, 4th Cavalry, conducting a reconnaissance mission in the lower Boi Loi Woods (XT540325) engaged one enemy with organic weapons. The enemy was captured along with two K-54 pistols and $\frac{1}{2}$ pound of documents. The documents identified the Political and Security sections of SR-1. Three hours later (1300 hours) at the same location (XT540325), Troop A engaged an unknown number of enemy with hand grenades resulting in three NVA KIA and one prisoner-of-war. They also evacuated eight pounds of documents. At 1625 hours Troop A captured an additional five prisoners-of-war and received one Hoi Chanh while evacuating two AK-47 rifles and one K-54 pistol one kilometer northwest of the previous contacts (XT546330). During the initial interrogation of the PWs, one of them identified himself as Duong Quang Tien, the Executive Officer of the 2 Company, 2 Battalion, 268 Regiment. Documents taken from the PWs substantiated this identification. The total for this reconnaissance mission was three NVA KIA, seven prisoners-of-war and one Hoi Chanh.

Troop D, 3rd Squadron, 4th Cavalry conducting mini-Cav operations with elements of Company D, 2nd Battalion, 14th Infantry on the afternoon of 17 November in the Ho Bo Woods (XT590300) engaged an unknown number of enemy at 1610 hours with helicopter gunships and artillery resulting in eight NVA KIA.

Within the 3rd Brigade area of operations activity continued at a low level as enemy units remained in their Cambodian bases. The only significant operation within the 3rd Bde AO was on 19 November at 1625 hours when helicopters of the 116th Assault Helicopter Company with elements of Company D, 2nd Battalion, 27th Infantry received fire from ten NVA soldiers 5.5 kilometers northeast of Bao Trai (XT546107). The helicopter gunships returned fire with automatic weapons killing six of the enemy.

Activity in the 3rd Brigade, 9th Infantry Division TAOI maintained its moderate level during the period 16-22 November. One of the most significant aspects of 3-9 Inf Div operations has been the uncovering of caches containing vital materials and supplies which the enemy had planned to use during his Winter/Spring offensive.

In a little over a three hour period on 19 November, soldiers of the 3-9 Inf Div uncovered three caches whose loss the enemy could ill-afford. At 1000 hours the Raider Platoon, 6th Battalion, 31st Infantry with ACVs operating four kilometers southwest of Saigon on the Ben Luc River uncovered a cache and evacuated 357 pounds of explosives, 72 rounds of RPG ammunition, 160 Chi-Com hand grenades, 5000 rounds of small arms ammunition, 30 82mm mortar rounds,

82 82mm mortar fuses, 74 rifle grenades and 100 blasting caps. One and one-half hours later, the Reconnaissance Platoon, 5th Battalion, 60th Infantry uncovered a cache three kilometers north of Ap Tan Thuan on the west bank of the Vam Co Dong River (XS682663) and destroyed 70 homemade AP mines, 12 Chi-Com hand grenades, 33 time fuses and one booby trapped round of 105mm ammunition. They also evacuated $\frac{1}{2}$ pound of documents. At 1315 hours, Raider/5-60 Inf with National Police uncovered a second cache at the same location (XS682-663) from which they evacuated 10 pounds of medical supplies, 100 homemade AP mines, 120 ChiCom hand grenades, 500 blasting caps, 15 pounds of C4 explosive and one US starlight scope.

On 17 November at 1205 hours while conducting a ground reconnaissance Company B, 2nd Battalion, 60th Infantry and the 478 Regional Force Company supported by Troop B, 3rd Squadron, 17th Air Cavalry and 190th Assault Helicopter Company, operating 2.5 kilometers northwest of Ap Tan Thuan (XS649651) engaged an unknown number of enemy with organic weapons, two light fire teams, and four helicopter gunships resulting in 18 VC KIA. US troops captured 22 AK-47 rifles and one SKS rifle. They also received 11 Hoi Chanh, one of whom was classified as VCI. Nine of the Hoi Chanh identified their unit as the Tan Tru Local Force Company. There were no US casualties.

Team 11, Company E, 75th Infantry (Ranger) located seven kilometers west of the "Pineapple" (XS465835) engaged an unknown number of enemy at 0035 hours on 20 November with small arms, automatic weapons, light fire team and artillery resulting in three NVA KIA. The Rangers evacuated 24 hand grenades, one AK-47 rifle, 40 rounds of RPG ammunition, 40 AP mines and three cases of batteries.

According to information gained on 22 November from a Hoi Chanh, Dang Van Hoi, from the SR-6 Political Section, the units subordinate to SR-6 were extensively reorganized following their decimation during the unsuccessful Summer Campaign. The N14 and N15 Battalions were deactivated with their personnel being reassigned to Sub-Regions 2 and 3. The N16 Battalion and N18 Artillery Company were resubordinated to SR-2. The N10 Battalion remained in SR-6 and the NVA members were transferred out of the unit. The N13 Battalion also remained assigned to SR-6. The N19 Battalion, SR-6, was disbanded and its personnel used as replacements for the N10, N13 and N16 Battalions.

The week 23-30 November was marked by a decrease in enemy activity. In Sub-Region 1 the level of enemy activity remained light. For the most part, main force units seemed to be trying to preserve their forces by breaking down into company and platoon size elements or remaining in secure areas in order to avoid contact. Those enemy units engaged still tended to be rear service guerrilla elements. Enemy activity was also light in Sub-Region 2 with activity consisting primarily of troop movement and reconnaissance. Sub-Region 3 units continued their low level of activity during the last week of November.

Division intelligence sources indicated that enemy forces intended to

CONFIDENTIAL

launch an offensive highpoint on 5-6 December. A high threat period would exist from 3 to about 11 December. However, in most areas any offensive action will be constrained by major logistical and replacement problems. The areas nearest Cambodian sanctuaries would most likely be least affected by such difficulties, making the An Ninh Corridor the most likely target for the heaviest enemy activity.

In the 1st Brigade area of operations, the heaviest contact centered around areas of traditional VC/NVA operations - the Straight Edge Woods, Nui Ba Den and the Boi Loi Woods. Five shelling incidents were noted during this period, none of which resulted in any American casualties. This is a significant decrease from the expected enemy activity and lends more evidence to the fact that enemy forces have been unable to mass (replacements, munitions, supplies) for the Winter/Spring Campaign.

Company D, 3rd Battalion, 22nd Infantry with Company A, 2nd Battalion, 34th Armor engaged an unknown number of enemy at 0945 hours on 25 November on the northeastern side of Nui Ba Den (XT276609). US troops engaged the enemy with small arms, automatic weapons, light fire team, Air Force Forward Air Controller, TAC air strikes and artillery resulting in 25 NVA KIA. The enemy returned fire with small arms, automatic weapons and 60mm mortar fire killing one US soldier and wounding seven. Light damage was sustained by one UH1H.

At 1737 hours on 25 November Company C, 2nd Battalion (Mechanized), 22nd Infantry, conducting a reconnaissance mission four kilometers south of the Ben Cui Rubber Plantation (XT453413), engaged an unknown number of enemy with small arms, automatic weapons, light fire team and artillery resulting in four NVA KIA. The enemy returned fire with small arms, automatic weapons and RPGs killing two Americans and wounding 19 others. The following afternoon Company A, 4th Battalion, 9th Infantry and Company A, 2-22 Inf (M) on a sweep through the contact area located four additional enemy dead, bringing the total number of enemy killed to eight.

On 26 November at 1859 hours, the Reconnaissance Platoon, 3rd Battalion, 22nd Infantry conducting Bushmaster operations four kilometers north of Trung Lap (XT178593) engaged 20 enemy 200 meters west of their position and six enemy 100 meters west of their position with organic weapons, light fire team, artillery and flareship. The enemy returned fire with small arms and immediately withdrew to the east and west leaving eight dead behind. No US casualties were sustained in this action.

An air observer from II Field Force Vietnam Artillery observed a bunker complex with an unknown number of enemy in the open 200 meters north of the Straight Edge Woods (XT138367) at 1240 hours on 27 November. Artillery engagement of the target resulted in nine enemy killed, seven bunkers destroyed and one secondary explosion.

CONFIDENTIAL

In the 2nd Brigade area of operations, enemy activity was heaviest in the area of responsibility of the 1st Battalion (Mechanized), 5th Infantry (XT5116 - XT6222) - the lower Citadel from Trang Banz to Trung Lap. During the period 22-30 November, elements of 1-5 Inf (M) accounted for 38 enemy killed.

The largest single engagement in the 2nd Brigade's AO occurred at 2014 hours on 25 November. A combat patrol from Company A, 1st Battalion (Mechanized), 5th Infantry located four kilometers southeast of Trung Lap (XT563185) engaged seven enemy 40 meters northeast of their position with organic weapons resulting in two NVA KIA. A sweep of the contact area by A/1-5 Inf (M) between 0700-0730 hours the morning of 26 November located five additional enemy killed during the ambush and one AK-47 rifle which was evacuated.

At 1232 hours on 28 November, Company A, 1st Battalion (Mechanized), 5th Infantry while conducting a reconnaissance mission three kilometers southeast of Trung Lap (XT565192) located in a water hole and destroyed 22 rounds of RPG ammunition, 42 ChiCom hand grenades, seven US smoke grenades, eight pounds of TNT, two aiming stakes, 1200 rounds of .51 caliber ammunition and 20 ChiCom AT mines. One pound of documents was evacuated.

One of the two prisoners-of-war captured by Company B, 1-5 Inf (M) and the 132 Regional Force Company on 29 November seven kilometers north-east of Cu Chi identified himself as a member of the Quyét Thang Battalion. According to the PW there were 12-15 men in the group that he was with at the time he was captured, one of whom was the Executive Officer of the 1 Quyét Thang Battalion, who was killed during the encounter.

Units within the 3rd Brigade area of operation maintained surveillance of enemy infiltration routes and further disrupted enemy plans by destroying numerous caches containing vital supplies which the enemy could use during the proposed forthcoming offensive.

The only significant contact in the 3rd Brigade AO during the final week of November was on the night of 27 November at 2320 hours. A combined combat patrol of 1st Platoon, Company C, 1st Battalion, 27th Infantry (10 members) and 2nd Reconnaissance Company, 49th ARVN Regiment (eight members) engaged 15-20 enemy in two sampans seven kilometers southwest of Duc Hoa (XS558912) in the "Pineapple". Firing ceased after a two minute exchange. Six enemy were killed while one ARVN soldier was killed. There were no US casualties.

Late in the last week of November there was an increase in friendly initiated contacts in the 3rd Brigade, 9th Infantry Division's area of operations. This was due mainly to an increase in enemy troop movements to include rear service and support elements.

CONFIDENTIAL

On 26 November, a prisoner-of-war captured two kilometers northwest of Binh Phuoc following an ambush by Company A, 2nd Battalion (Mechanized), 47th Infantry identified his unit as the D3 Infiltration Group which consists of three rifle companies and one artillery company (approximately 556 men), most of whom were still in Cambodia at the time of his capture. This group may be replacements intended for the K-6 Battalion, 1 NVA Regiment which operates in the area of contact.

Company B, 2nd Battalion, 60th Infantry while conducting Jitterbug operations on 27 November engaged one enemy soldier at 1840 hours seven kilometers northwest of Binh Phuoc (XS554583) killing the enemy soldier. One hour later (1950 hours), B/2-60 Inf in pursuit of an unknown number of enemy 400 meters southwest of the earlier contact (XS554582) killed an additional six enemy with organic weapons, light fire team, Navy gunships, Air Force Forward Air Controller and artillery.

On 28 November at 1300 hours, Company C, 6th Battalion, 31st Infantry received fire from an unknown number of enemy in bunkers two kilometers west of Can Duoc (XS735607). Returning fire with organic weapons, light fire team and artillery, US troops accounted for eight NVA KIA and captured two prisoners-of-war. One US soldier was killed and seven others wounded in this engagement. US troops captured one AK-47 rifle, one M-16 rifle and one RPG launcher. Prisoner interrogation resulted in identifying the enemy unit engaged as the C1 Company, 520 Main Force Battalion of Sub-Region 3.

At 1615 hours on 30 November, Company B, 2nd Battalion (Mechanized), 47th Infantry engaged a suspected enemy location five kilometers southeast of Ap Tan Thuan on the south bank of the Vam Co Tay River (XS688582) with artillery. A sweep of the area located 20 NVA dead. At 1850 hours B/2-47 Inf (M) apprehended five detainees, of whom three were wounded, one kilometer southwest of the earlier contact. After interrogation the five detainees were reclassified as prisoners-of-war. One of the PWs, Nguyen Thi Ba Choc, a female doctor, was a southern Communist assigned to the Binh Phuoc District Hospital. The subject stated that her primary mission was to treat wounded southern Communists and NVA. Her secondary mission was to perform MEDCAPS among the civilian population as a part of the district anti-pacification campaign. However, during the past year the lack of medical supplies and the presence of GVN/US MEDCAPS have prevented her unit from treating the local civilians. She further stated that nothing had been more effective in isolating the Communists from the people than the FWMAF MEDCAPS, especially when Vietnamese are a part of the MEDCAP.

At 1935 hours B/2-47 Inf (M) with gunships of the 190th Assault Helicopter Company observed movement in the area of the earliest contact (XS688582) and engaged the area with organic weapons and helicopter gunships. A sweep of the area located five NVA KIA and two K-54 pistols. The result of this day's operations were 25 NVA KIA and five prisoners-of-war.

CONFIDENTIAL

As the month of November ended the expected enemy highpoint had not yet begun, nor had the expected increase in enemy activity at the end of the month been realized. Because of the continued lack of replacements, munitions and supplies, the VC/NVA timetable has had to be moved forward. Preemption of enemy plans by Allied operations still is one of the most decisive factors in making the Winter/Spring Campaign as ineffective as was the Summer Campaign.

During the month of November Division troops destroyed 330 mines and booby traps and detonated 115, resulting in 107 wounded and 11 US soldiers killed. The Division sniper program continued to improve during the month of November as a total of 80 kills were recorded.

In November the 25th Infantry Division and 3rd Brigade, 9th Infantry Division killed 1106 enemy soldiers, captured 72 prisoners-of-war, and captured or destroyed 312 individual weapons, 31 crew-served weapons and 2,92 tons of rice. The Chieu Hoi Program in the Division area received 455 Hoi Chanh. In pacification efforts, the Division conducted 3410 broadcast and 8498 leaflet missions and treated 73,374 patients. Combined operations for the month totaled 1,689.

The first week of December (1-8 December) revealed a continuance in the low level of enemy activity with a continued emphasis on economy of force as noted by a high preponderance in mining and booby trap incidents. During this period there were reported 165 incidents involving mines or booby traps detonated or destroyed. The 5-6 December highpoint had failed to materialize as the VC/NVA forces within the Division area of operations continued to suffer from lack of supplies and replacement personnel.

In the 1st Brigade area of operations there were six shelling incidents, all directed against Tay Ninh Base Camp (XT1652). No US casualties, equipment or material losses resulted.

Two significant contacts occurred in the 1st Brigade area of operations during this period. At 1900 hours on 1 December, a combat patrol from Company A, 2nd Battalion (Mechanized), 22nd Infantry spotted approximately 30 enemy crossing an open field four kilometers southwest of Ben Cui (XT434-412). This force was engaged with artillery from Battery C, 7th Battalion, 9th Artillery, Battery C, 7th Battalion, 11th Artillery and 81mm mortars from A/2-22 Inf (M) night defensive position. The following morning (2 December) at 0930 hours, A/2-22 Inf (M) made a sweep of the area where movement was engaged the previous night and located 19 NVA KIA. One-eighth of a pound of documents were evacuated along with one AK-47 rifle.

At 0930 hours on 4 December an Air Force Forward Air Controller with CIDG's engaged an estimated 20-30 enemy in the vicinity of what appeared to be a camouflaged armored vehicle nine kilometers northwest of Ben Soi (WT957498) with organic weapons and air strikes resulting in eight enemy

22

CONFIDENTIAL

CONFIDENTIAL

killed and three secondary explosions. Company C, 3rd Battalion, 22nd Infantry was inserted in this location (WT957500) and found an enemy base camp. At 1302 hours, C/3-22 Inf uncovered a cache located 100 meters west of the earlier contact (WT956498) and destroyed four tons of rice, 73 rounds of 60mm mortar ammunition, 19 ChiCom hand grenades, six oxcarts, four bicycles and two structures. Twenty-five pounds of documents and three SKS rifles were evacuated. Two enemy soldiers found at the cache site were killed by small arms and automatic weapons fire.

In the 2nd Brigade area of operations two shelling incidents were reported on the last day of the week, neither causing any casualties or damage.

On 1 December 1969 the 2nd Brigade initiated a surveillance plan to counteract movement of small enemy units within the TAOI. Through careful analysis of past enemy activity, it was learned that enemy movement took place predominantly at the hours of dawn and dusk. Maximum aerial surveillance was initiated at these prime hours, consisting of all air assets available to 2nd Brigade, including Air Force FACs. The first significant contact under this maximum aerial surveillance concept came on 7 December when an Air Force FAC working with a 2nd Brigade light observation helicopter (LOH) on Dawn Surveillance engaged an unknown number of enemy in the open at 0720 hours eight kilometers northeast of Trung Lap in the Ho Bo Woods (XT605295). Artillery and automatic weapons engagement accounted for six NVA KIA. The following day (8 December) an Air Force FAC with a 2nd Brigade LOH on Dusk Surveillance engaged two enemy at 1725 hours seven kilometers northeast of Trung Lap in the Ho Bo Woods (XT612285) with an air strike and artillery resulting in one known enemy killed. These early successes with this concept reveals clearly the difficulty the enemy is experiencing in initiating offensive operations due to preemptive activity by the 25th Infantry Division operations.

A combat patrol from Company D, 2nd Battalion, 12th Infantry located in the northern Citadel (XT510311) on 2 December engaged an unknown number of enemy walking in the open along a trail 30 meters northeast of their position at 1915 hours. Small arms, automatic weapons, claymore mines and helicopter gunships resulted in 12 NVA KIA. Nine AK-47 rifles, ten pounds of documents and 1000 \$VN were evacuated after the contact. There were no US casualties. A readout of the captured documents identified the 268 Regiment.

At 1345 hours on 2 December, the Scout Platoon, 1st Battalion (Mechanized), 5th Infantry with the 158 Regional Force Company operating seven kilometers east of Trang Bang (XT566184) engaged an unknown number of enemy in a hedgerow with a flame track resulting in three prisoners-of-war captured. One AK-47 rifle, one K-54 pistol and 15,000 \$VN were evacuated.

Company E, 65th Engineer Battalion with elements of Company C, 1st Battalion (Mechanized), 5th Infantry captured two prisoners-of-war and two AK-47 rifles at 1450 hours on 6 December four kilometers northwest of Cu Chi (XT625185) when a bulldozer uncovered a hole in which the two enemy had been hiding. One hour later (1556 hours) and 100 meters to the southwest (XT624184), C/1-5 Inf (M) with elements of Company B, 2nd Battalion, 14th Infantry exploiting information from the two PWs captured earlier, captured an additional two prisoners-of-war. One RPD light machine gun and one M-16 rifle were evacuated while one hand grenade and 200 rounds of small arms ammunition were destroyed. Interrogation of the PWs identified the 3 Company, 1 Battalion, Quyet Thang Regiment, Sub-Region 1 and revealed that the PWs were on a rice transportation mission when captured.

Seven kilometers northeast of Trung Lap (XT608289) in the Ho Bo Woods, Company D, 2nd Battalion, 14th Infantry killed three NVA soldiers after engaging an unknown number of enemy with organic weapons at 0845 hours on 7 December. Two hours and twenty minutes later (1105 hours), D/2-14 Inf engaged another group of enemy one kilometer northeast of the earlier contact (XT605292) resulting in an additional five NVA KIA.

Activity within the 3rd Brigade area of operations continued on a very low level with no significant contacts during the week. 1st and 2nd Battalions, 27th Infantry maintained a close surveillance on the An Ninh Corridor for the eventual infiltration of SR-2 units who remained in their Cambodian sanctuaries.

In the 3rd Brigade, 9th Infantry Division area of operation, enemy operations consisted mostly of reconnaissance and resupply activities.

At 0505 hours on 2 December, Company B, 5th Battalion, 60th Infantry with elements of the Reconnaissance Platoon, 6th Battalion, 31st Infantry and ACV's observed 10-11 enemy making a ground probe of Fire Base Gettysburg (XS355875) from the northwest. One light fire team, an AC-119 "Shadow" and artillery engaged this force killing five of the enemy. One-half pound of documents was evacuated.

Company B, 5th Battalion, 60th Infantry engaged two enemy at 1515 hours on 4 December following a combat assault six kilometers northwest of Rach Kien (XS694727). Continuing their reconnaissance, B/5-60 Inf located the bodies of ten NVA soldiers killed by the two air strikes and artillery preparation preceding their combat assault.

A Hoi Chanh who rallied on 4 December at Can Duoc (XS7661) identified himself as the Company Commander of the C1 Company, 520 Battalion, Sub-Region 3. According to the Hoi Chanh, he rallied because he was tired of fighting. During the interrogation the rallier stated that the Battalion's mission was to counter the pacification effort in Can Duoc District. Re-

CONFIDENTIAL

cent losses by the 520 Battalion had been extensive enough that the Battalion's plans for the Winter Offensive may have been disrupted.

A Navy PBR engaged six enemy in a sampan at 2245 hours on 8 December seven kilometers south of Co Dau Ha on the Vam Co Dong River (XT395183) with organic weapons, but could not determine the results. A Night Hawk helicopter checking the area of contact located six enemy bodies.

Ranger activities in the 3-9 Inf Div AO accounted for 18 enemy killed in four separate contacts during the first week of December. Teams 24 and 17, Company E, 75th Infantry (Ranger) were inserted on a radar intelligence target six kilometers south of Tan An (XS544584) on 1 December. At 1849 hours the combined teams engaged 20 enemy with organic weapons, artillery and helicopter gunships resulting in five NVA KIA and the apprehension of one detainee. On 5 December at 2143 hours Team 17 operating near the Vam Co Tay River (XS480737) engaged eight to ten enemy with organic weapons, TAC air strikes, AC-119 "Shadow" and artillery resulting in three NVA KIA. At 1015 hours on 6 December a helicopter gunship from Troop B, 3rd Squadron, 17th Air Cavalry located an additional two NVA bodies at the contact site (XS480737).

Team 14, E/75 Inf (Rgr), reacting to a radar sighting engaged nine enemy with organic weapons at 2245 hours on 7 December four kilometers southeast of Can Giuoc (XS863705) killing three of the enemy. The following day at 0845 hours a helicopter gunship from Troop B, 3rd Squadron, 17th Air Cavalry located one additional enemy body at the contact site.

On 8 December elements of the 50th ARVN Regiment located twelve bodies in a hospital area five kilometers southwest of Can Duoc (XS712579) which were credited to 2nd Battalion (Mechanized), 47th Infantry contacts in the vicinity of XS6859 from 28 November to 1 December.

Enemy initiated activity increased throughout the Division TAOI during the second week of December (9-16 December). Areas of concentrated enemy activity were around Nui Ba Den, the Citadel-Trang Bang area, north of the Sugar Mill and northwest of Binh Phuoc. Emphasis continued to be placed in rear service activity in preparation for the Winter/Spring Offensive.

Enemy activity in Sub-Region 1 remained at a moderate level during this week. The center of enemy activity shifted to the Ho Bo Woods - Citadel area as SR-1 units devoted their efforts to the procurement and movement of supplies, primarily food. There was an increase in the activity of SR-1 support units, principally on the part of the artillery battalions, as several attacks by fire were launched against US fire support and patrol bases in the Citadel. In Sub-Region 2, the level of enemy initiated activity picked up appreciably during the week, with attacks by fire the main tactic being employed. Within Sub-Region 3

CONFIDENTIAL

enemy efforts continued to be directed towards disruption of the pacification program in Long An Province.

In the 1st Brigade area of operations the major contacts centered around Nui Ba Den and northwest of Tay Ninh City. Only one shelling incident was reported in the 1st Brigade TAOI during the second week of December. At 0220 hours on 10 December, Company A, 3rd Battalion, 22nd Infantry, at Fire Support Base Washington (XT146568), observed 25 rounds of 82mm mortar fire impact 100-200 meters outside the wire. There were no casualties.

On 9 December at 2250 hours, 3rd Battalion, 22nd Infantry at FSB Crook engaged an unknown number of enemy with organic weapons after observing two enemy 150 meters north of the base. On a sweep of the area the following morning (100700), C/3-22 Inf located six enemy bodies 600 meters northeast of the base (XT062597), captured one wounded prisoner-of-war and evacuated three RPG launchers, three AK-47 rifles, 40 satchel charges, 13 RPG rounds, 41 ChiCom hand grenades, two Soviet hand grenades, and one Japanese commercial walkie-talkie. During interrogation the PW identified himself as a member of the 48 Company, 9 Sapper Battalion. The Battalion may be the 8 Sapper Battalion of COSVN's 16 Armor Office, since it has a 48 Company and the 9 Sapper Battalion has not been identified by Order of Battle.

The most active of the 1st Brigade units during this week was the 2nd Battalion, 34th Armor. The initial action, which resulted in a five day total of 49 enemy killed, began on 11 December at 1500 hours. Company A, 2-34 Armor on the northeastern slope of Nui Ba Den (XT292601) located eight enemy killed by artillery fired at Duffel Bag activations. One-half hour later (1530 hours) A/2-34 Armor located an additional eight enemy bodies 700 meters southeast of the previous discovery (XT293594). These enemy had also been killed by artillery as a result of Duffel Bag activations. On 14 December A/2-34 Armor uncovered a small cache in a cave at 1135 hours 500 meters north of the 11 December activity (XT290595). At 1200 hours, A/2-34 Armor received sniper fire from two enemy soldiers wounding one US soldier. Returning fire with organic weapons, the two enemy snipers were killed. At 1230 hours, A/2-34 Armor received two rounds of 60mm mortar fire. US troops returned fire with organic weapons, three light fire teams, one light scout team, two air strikes, three flame bath-drops and artillery (70 rounds). The enemy broke contact at 1400 hours leaving eight dead behind. The following afternoon (15 December) at 1255 hours, A/2-34 Armor received sniper fire from an unknown number of enemy 300 meters southeast of the 14 December contact (XT293593). A/2-34 Armor returned fire with organic weapons, artillery, light fire team, flame bath drop, and air strikes accounting for three enemy killed. At 1600 hours, the Commanding Officer, 2-34 Armor, on a visual reconnaissance flight of the contact area, observed 13 additional enemy bodies, to bring the total number of enemy KIA's to 16.

CONFIDENTIAL

Six shellings were reported in the 2nd Brigade area of operations during the period 9-13 December. Although an increase over the previous week, no US casualties were inflicted.

The 2d Battalion, 12th Infantry accounted for 21 enemy killed and 13 prisoners-of-war in nine scattered contacts in the Citadel area during the period 10-14 December. The largest contact developed on 14 December at 1236 hours when Company D, 2nd Battalion, 12th Infantry engaged ten enemy in bunkers eight kilometers north of Trung Lap (XT591301). Nine of the enemy were killed and one wounded prisoner-of-war was captured.

On 16 December gunships from the 116th AHC operating with B/2-14 Inf nine kilometers east of Trung Lap (XT678222) engaged 10-14 enemy with organic weapons at 1615 hours resulting in seven enemy killed.

On 10 December elements of 1st Battalion (Mechanized), 5th Infantry killed ten enemy, captured six prisoners-of-war and located six enemy bodies in scattered contacts in the Ho Bo Woods. At 1536 hours, Company C, 1-5 Inf (M) captured six PWs from the G35 Company, 10 Artillery Battalion, to include one finance officer and two squad leaders eight kilometers north of Trung Lap (XT586294). The enemy had been on a rice procuring mission for their unit at the time of capture. At 1930 hours a combat patrol from A/1-5 Inf (M) while on their way to an ambush site engaged 10-15 enemy eight kilometers northeast of Trung Lap (XT660250). When the enemy were within 150 meters northeast of the patrol, they were engaged with organic weapons, two light fire teams, two flareships, one Night Hawk, one AC-47 "Spooky" and artillery (17 rounds). Seven enemy were killed and three blood trails were located along with numerous pools of blood. On 16 December Company B, 1-5 Inf (M) operating nine kilometers northeast of Trung Lap (XT2528) located eight enemy killed as a result of a preplanned air strike of this area on the morning of 16 December.

On 9 December at 1030 hours, Troop C, 3rd Squadron, 4th Cavalry with Company A, 2nd Battalion, 34th Armor engaged an unknown number of enemy in bunkers eight kilometers north of Trung Lap (XT574295) in the Ho Bo Woods. Organic weapons, three light fire teams, an Air Force FAC and three TAC air strikes accounted for four enemy killed. Two US soldiers were wounded by enemy small arms fire. One RPG launcher and one RPG booster were evacuated along with $\frac{1}{2}$ pound of documents. In a sweep of the contact area the following day (10 December), C/3-4 Cav located nine additional enemy killed bringing the body count to 13 for the previous day's action. Troop A, 3-4 Cav located ten enemy killed by artillery seven kilometers southwest of Ben Suc (XT511311) at 1130 hours on 13 December. Four hours later (1530 hours), A/3-4 Cav located an additional two enemy killed by artillery one kilometer southwest of the earlier discovered bodies (XT496308).

CONFIDENTIAL

On 15 December at 1130 hours, C/3-4 Cav was led to a large weapons cache by an RF Company from Bao Trai. The RF's had been helilifted into the 2nd Brigade area to exploit information they had developed from a Hoi Chanh at the Bao Trai Chieu Hoi Center. From the cache located nine kilometers north of Trung Lap (XT573310), one flame thrower, five .51 caliber machine guns, 309 CKC rifles, one AK-47 rifle, five M3 submachine guns, seven carbines, three rounds of 81mm mortar ammunition, 26 rounds of 75mm recoilless rifle ammunition and one 105mm round were evacuated.

Enemy initiated activity increased in the 3rd Brigade area of operations as six shelling incidents were reported in a four day period. The heaviest shelling took place on 11 December when the Combined Reconnaissance Intelligence Platoon, 1st Battalion, 27th Infantry at the Duc Hoa Compound (XS608946) received eight rounds of mortar fire at 2235 hours. One hour later (2335 hours) the compound received an additional nine mortar rounds. No US casualties resulted from either shelling.

At 1045 hours on 13 December the 29 Popular Force Platoon, operating five kilometers southwest of Go Dau Ha (XT349215) engaged an enemy company which had been firing on the Binh Thanh Outpost (A/2-27 Inf) with organic weapons and artillery (280 rounds). Firing ceased at 0300 hours as the enemy withdrew to the southeast, leaving behind 25 dead. Two PF soldiers were wounded during the engagement.

Eight enemy soldiers were killed in three scattered incidents in the "Sugar Mill" (XT4307) during the period 9-12 December by soldiers of the 1st and 2nd Battalions, 27th Infantry. Enemy activity remained moderate though as main force units still avoided contact in the 3rd Brigade area of operations.

Company B, 2nd Battalion, 27th Infantry received small arms fire from an unknown number of enemy while inserting in a LZ at 1510 hours on 12 December three kilometers northwest of Hiep Hoa (XT416093). Returning fire with organic weapons and light fire team, US forces killed five enemy and destroyed one RPD light machine gun. One US soldier was killed and four wounded during the initial engagement. One of the helicopter gunships received small arms fire wounding one of its personnel. At 1330 hours on 13 December, C/2-27 Inf swept the contact area and located one 60mm mortar with baseplate and sight, three AK-47 rifles, two pounds of documents and 15 pounds of medical supplies, all of which were evacuated. Seven ChiCom hand grenades were destroyed.

In the 3rd Brigade, 9th Infantry Division TAOI there was an increase in enemy activity as 49 enemy soldiers were killed by US fires during the second week of December. The largest single action occurred on 14 December when Companies B, C and D, 2nd Battalion, 60th Infantry and the 487th Regional Force Company with gunships from Troop B, 3rd Squadron, 17th Air Cavalry and 128th Assault Helicopter Company engaged an unknown number of enemy four kilometers northeast of Can Duoc (XS7364) at 1300 hours. Organic weapons and helicopter

CONFIDENTIAL

gunships engaged this force killing 20 of the enemy. One US soldier was killed and four others wounded by returned enemy fire. Three K-54 pistols, one US caliber 45 pistol, four AK-47 rifles, one RPG launcher, 18 NVA packs and 1300 small arms rounds were evacuated. Two ChiCom hand grenades, three rifle grenades and five RPG rounds were destroyed. At 1345 hours on 15 December a C&C ship from 6th Battalion, 31st Infantry located three enemy dead in the area of the 2-60 Inf contact of 141300. Captured documents identified the 520 Battalion, Sub-Region 3 as the enemy force engaged.

On the evening of 9 December (1943 hours) Company B, 2nd Battalion (Mechanized), 47th Infantry and 2-50 ARVN engaged an unknown number of enemy eight kilometers northeast of Tan An (XS593555). The enemy were engaged with organic weapons at a distance of 250 meters from the unit's position. Contact was lost at 2005 hours and a sweep of the area located one enemy body. An agent report received the following day stated that a Vietnamese civilian saw the enemy carrying seven dead from the area of contact after they evaded the allied forces.

On 10 December at 0910 hours, gunships of the 240th Assault Helicopter Company supporting the 627th Regional Force Company eight kilometers northeast of Tan An (XS620687) engaged an unknown number of enemy with automatic weapons resulting in 23 NVA KIA.

Team 21, Company E, 75th Infantry (Ranger) with Company D, 6th Battalion, 31st Infantry and Troop B, 3rd Squadron, 17th Air Cavalry engaged an unknown number of enemy at 0745 hours on 12 December four kilometers northwest of Binh Phuoc (XS598590). Organic weapons, helicopter gunships, Air Force Forward Air Controller and artillery (82 rounds) killed 26 of the enemy. Four K-54 pistols, one AK-47 rifle, two 60mm mortar rounds, one pound of documents and one field radio were evacuated. While sweeping the contact area one US soldier from D/6-31 Inf was killed and one wounded when an unknown type booby trap was detonated. One US soldier was also wounded when a LOH from E/3-17 Air Cav received small arms fire. Captured documents identified the C20 Signal and Ordnance Company, 1 NVA Regiment. An incident mentioned in the documents concerning a recent shipment of hand grenades, two-thirds of which did not explode. During the past three months Sub-Region 3 forces have experienced logistical problems including inadequate and defective supplies.

Documents captured northwest of Ben Suc (XT569374) on 5 December indicated that a plan dated 25 November 1969, possibly prepared by the Current Affairs Committee of SR-1 in accordance with COSVN Resolution Nine, provides an extensive Political Motivation Campaign to be conducted in SR-1 from November 1969 to January 1970. The documents stated that intensive propaganda and indoctrination efforts are to be made to convince cadre, soldiers and civilians that the communists are in a winning position. A circular dated 28 November revealed that a politico-civilian congress will be convened by the Current Affairs Committee from 15 to 25 December, to review recent proselyting achievements, analyze the GVN Pacification Program, and restudy

CONFIDENTIAL

COSVN Resolution Nine. A final document, classified VC Absolute Secret and dated 29 November, revealed that the Sub-Region (1) had been able to accomplish only 10-17 percent of the goals set by COSVN during Phase I of the Winter Campaign. This report also disclosed that main force units of the Sub-Region were unable to attack their targets due to a lack of leadership. Other problems mentioned were that the population was fleeing to GVN controlled areas and that efforts to shatter the pacification program were unsuccessful, while the procurement of food still constituted a major problem. These documents confirm previous intelligence reports and discloses the fact that SR-1 is making a concerted effort to bolster sagging morale throughout its area.

During the week 17-24 December enemy initiated activity remained at a low level throughout the Division TAOI. Rear service activity and avoidance of contact were the primary concern of main force units, while indoctrination, harassment and the movement of supplies were the main activities of the local force units. Recent intelligence indicated that the enemy has postponed his Winter/Spring Offensive until after the holiday cease fire. This postponement was necessitated by the continuing critical shortages of foodstuffs, materials and replacements imposed upon all enemy units by Allied activities.

There was only one significant contact in the 1st Brigade area of operations during the third week of December. On 18 December Company A, 2nd Battalion (Mechanized), 22nd Infantry received small arms, automatic weapons and RPG fire from an unknown number of enemy at 1425 hours ten kilometers southwest of the Ben Cui Rubber Plantation (XT478358) in the Boi Loi Woods. Organic weapons, one light fire team, an Air Force Forward Air Controller, air strikes and artillery accounted for 14 enemy killed. Enemy return fire killed two US soldiers and wounded six others. A helicopter gunship from Company B, 25th Aviation Battalion supporting the action (AH1G - Cobra) was forced down by ground fire which damaged the ship's hydraulic system. Upon landing the crew was able to take cover near 2-22 Inf (M) APC's. A Chinook helicopter was flown in to remove the damaged ship but was unable to lift it out because of enemy fire. The AH1G was finally repaired on the ground and flown out. A/2-22 Inf (M) broke contact at 1730 hours to allow air strikes on the enemy position, The Air Force FAC putting in the first two of 15 air strikes spotted colored smoke at the contact site. Upon confirmation there were no friendly troops in the area, the FAC used the smoke as an adjusting point. The following morning (19 December) at 0820 hours, A/2-22 Inf (M) engaged and killed one enemy while sweeping the area of the previous day's contact.

Eight kilometers southwest of Trai Bi (XT199659) at 0045 hours on 23 December, a combat patrol from Company A, 4th Battalion, 9th Infantry engaged 12 enemy with organic weapons, a Night Hawk helicopter and artillery. Five of the enemy were killed, one SKS, one 9mm pistol, two AK-47 rifles, five pounds of medical supplies and two pounds of documents were evacuated. The documents mentioned the D14 Battalion but contained no tactical information.

CONFIDENTIAL

Only four shelling incidents were reported in the 1st Brigade area of operations, all taking place on the evening of 17-18 December. The heaviest attack by fire was directed against Tay Ninh Base Camp (XT1652) when it received 53 rounds of 122mm rockets beginning at 0035 hours on 18 December. One US soldier was wounded, moderate damage was sustained by two UH1H helicopters and three UH1H helicopters received light damage.

In the 2nd Brigade area of operations, shelling incidents were maintained at a moderate level. Of the six incidents reported, five were directed against night laager positions of Troop A, 3rd Squadron, 4th Cavalry. No US casualties were sustained during any of the reported shelling incidents.

A moderate level of enemy activity continued in the Citadel, Ho Bo Woods and lower Boi Loi Woods area as 2nd Brigade elements accounted for 104 enemy killed and 19 prisoners of war in 49 separate contacts during the period 17-24 December. There were no large contacts as main force elements continued to operate in dispersed formations and to avoid meeting allied forces in open combat. The enemy personnel engaged were usually on food procuring or transportation missions rather than an offensive operation.

2nd Brigade elements continued to preempt any enemy offensive plans by destroying the vital supplies so necessary to enemy plans. On 19 December at 1220 hours, Company A, 2nd Battalion, 14th Infantry, eight kilometers north of Trung Lap (XT590298) located a cache and evacuated two machine gun tripods, four light machine guns, and 300 rounds of small arms ammunition. Destroyed were 20 pounds of explosives, six AT mines, 14 75mm recoilless rifle rounds and five HE rounds. At 1035 hours the same morning Troop B, 3rd Squadron, 4th Cavalry evacuated 350 pounds of medical supplies from a cache located 2.5 kilometers west of Ben Suc in the lower Boi Loi Woods (XT495328) and evacuated 20,000 rounds of small arms ammunition, one carbine, 1000 pounds of rice and one 107mm rocket warhead. Destroyed were three rifle grenades, seven RPG rounds, two hand grenades, one M-72 LAW and 4000 rounds of small arms ammunition.

At 2135 hours on 23 December the night laager position of Company C, 1st Battalion (Mechanized), 5th Infantry, located 6.3 kilometers west of Trung Lap (XT527215), received 12 rounds of 82mm mortar fire, all of which impacted outside the wire. Fire was returned by mortars, artillery and a light fire team with flareship illumination. At 2245 hours one of the helicopter gunships engaged five enemy with organic weapons killing three of the enemy. The following day (24 December) at 1245 hours, a 2nd Brigade Cavalry element located eight enemy bodies 500 meters southwest of the 23 December contact of G/1-5 Inf (M) (XT522214). Though no solid evidence relates these enemy to that contact, indications were that the enemy killed had been part of the force carrying out the attack by fire on the night laager position.

During the Christmas season many noted personalities visited the 25th

CONFIDENTIAL

Infantry Division at Cu Chi Base Camp (XT6313). The President of South Vietnam, Nguyen Van Thieu, visited Cu Chi on 22 December to offer Christmas greetings to the 25th Infantry Division from the people of the Republic of South Vietnam. On the afternoon of 23 December the Bob Hope Show was presented at the Lightning Bowl for the benefit of the men of the 25th Infantry Division, 1st Air Cavalry Division and 1st Infantry Division. On 23 December, Terrence Cardinal Cooke, Rome Catholic Archbishop of the New York Diocese, visited Cu Chi Base Camp and offered a Christmas Mass for the men of the 25th Infantry Division and all Americans serving in Vietnam.

There continued to be no major enemy activity in the 3rd Brigade area of operations through the third week of December. The only contact of any significance took place at 1850 hours on 17 December. Company A, 1st Battalion, 27th Infantry engaged an unknown number of enemy 4.5 kilometers west of Bao Trai (XT496005). Organic weapons and one light fire team accounted for five VCI KIA and the capture of three K-54 pistols. The enemy returned fire with small arms and automatic weapons wounding two US soldiers and killing another US soldier. Documents captured mentioned various sections of the Duc Hoa (D) Headquarters, SR-2, but contained no tactical information.

Elements of the 3rd Brigade, 9th Infantry Division accounted for 82 enemy killed and two prisoners-of-war in 21 separate contacts for the period 17-23 December.

At 2128 hours on 19 December, the Reconnaissance Platoon, 2nd Battalion (Mechanized), 47th Infantry received small arms, automatic weapons fire from an estimated enemy platoon seven kilometers southeast of Binh Phuoc (XS678535). Returning fire with organic weapons, helicopter gunships, mortars and artillery, US troops killed ten of the enemy, sustaining only minor damage to one UH1H. Two days later (21 December) at 2155 hours, R/2-47 Inf (M) engaged an estimated enemy platoon three kilometers northeast of the 19 December contact (XS-698559). Organic weapons, helicopter gunships and an AC-47 "Shadow" accounted for ten enemy killed. Three AK-47 rifles and five pounds of documents were evacuated. One US soldier was wounded when the enemy returned fire with small arms.

On 23 December at 1930 hours the Combined Reconnaissance Intelligence Platoon and the Raider Platoon, 5th Battalion, 60th Infantry engaged an unknown number of enemy with organic weapons, a light fire team, AC-47 "Shadow", and one artillery battery (372 rounds) five kilometers northeast of Rach Kien (XS713745). Ten enemy were killed by US fires with no US casualties being sustained.

The 25th Infantry Division assumed a dry season posture on 22 December 1969 to meet dry season conditions and to coordinate with planned changes in unit locations by the 25th ARVN Division. The 2nd Battalion (Mechanized), 22nd Infantry was shifted from 1st Brigade to 3rd Brigade to strengthen Division elements in that area of operations because of the high level of

CONFIDENTIAL

enemy activity within the 3rd Brigade TAOI and because this area is suitable for mechanized unit operations in the dry season. Along with the organization change, 2-22 Inf (M) moved its battalion rear area to Cu Chi Base Camp in the area previously occupied by 2nd Battalion, 34th Armor. 2-34 Arm moved its battalion rear area to Tay Ninh Base Camp as the unit operates within the 1st Brigade area of operations. 2-34 Arm had been previously unable to move its rear area because of the limited amount of space available at Tay Ninh Base Camp. This problem was eliminated by the shift of 2-22 Inf (M) and the withdrawal of the PHILCAGV from Vietnam. The 2nd Brigade area of operations was enlarged to include all of the Boi Loi Woods. An additional ARVN battalion moved into the 2nd Brigade AO to increase Allied potentials within the brigade AO. With an increased number of maneuver battalions the 3rd Brigade area of operations was extended northward to include responsibility for the security of Highway 1 from the Angel's Wing to south of Go Dau Ha and a portion of the MSR south of Go Dau Ha.

Also with the dry season posture the division adopted "floating brigade boundaries" to simplify procedures for temporary changes of brigade boundaries to allow operations to insure enemy units were not attempting to avoid contact by deploying near or on brigade boundaries. The "floating brigade boundary" consists of a series of small AO's along both sides of the brigade boundary each with a code designation. When a brigade requests a temporary AO extension to facilitate operations on or near the boundary, the requests only contain the code designation for the area desired.

The final week of December (25-31 December) was marked by a continued low to moderate level of enemy activity. The Citadel-Trang Bang area continued to be the center of enemy activity. Local forces concentrated their efforts in the procurement and movement of food and supplies, and the placement of mines and booby traps. The continued lull in enemy activity within the Division TAOI can probably be attributed to the interdiction by allied forces on supply lines to enemy main force units.

Documents captured earlier in the month near the Chau Doc/Cambodian Border (WS855613) revealed the possibility that the 101D Regiment has moved from III CTZ to IV CTZ. The 101D Regiment was the last major unit subordinate to the 1 NVA Division. The possible movement suggests that the 1 NVA Division has redeployed to IV CTZ.

Only two shelling incidents were reported in the 1st Brigade area of operations during the period 25-31 December. Only one US wounded was sustained during the attacks by fire. This sharp decrease in shelling incidents was due to the enemy generally honoring his announced holiday cease fires.

The area of most activity within the 1st Brigade AO was east and south-east of Trai Bi, as elements of the 4th Battalion, 9th Infantry accounted for 13 enemy killed and one prisoner-of-war in seven contacts. The largest

CONFIDENTIAL

contact took place at 2320 hours on 25 December when a combat patrol from Company C, 4-9 Inf engaged 11 enemy 100 meters from their ambush site five kilometers east of Trai Bi (XT174680). Fires from automatic weapons, small arms, one artillery battery (16 rounds), one light fire team and one flareship accounted for seven enemy killed from the 272 VC/NVA Regiment. Four AK-47 rifles, one helmet, one flashlight and five pounds of web gear were evacuated from the contact site.

Within the 2nd Brigade area of operations the numbers of shelling incidents also decreased in number. There were only three reported incidents. The heaviest, and one of the most costly during the reporting quarter, came at 0045 hours on 28 December. The company command group and a reinforced platoon from Company A, 2nd Battalion, 14th Infantry established a night defensive position eight kilometers northeast of Trung Lap (XT655270) just east of Highway 15. At 0045 hours the position received small arms, automatic weapons, RPG and 60mm mortar fire. Seven US soldiers were killed and five wounded by enemy fires. US troops returned fire with organic weapons, artillery, three light fire teams, TAC air strikes, AC-47 "Shadow" and one Night Hawk helicopter. At 0300 hours the night defensive position was reinforced by an airlifted platoon. Contact was lost at 0355 hours. A sweep of the contact area located three enemy bodies, two AK-47 rifles, one RPG launcher, three RPG rounds and ten ChiCom hand grenades.

At the evening briefing on 28 December Major General Hollis stated that the attack of the A/2-14 Inf night defensive position was an example of the new type sapper tactics for which the enemy had been training. There were probably twelve or less sappers involved, supported by indirect artillery fires. The area in which A/2-14 Inf was located is the area of operations of the 268 Regiment of which the 1st and 3rd Battalions had recently completed sapper training.

Between the period 25 to 31 December, US forces of the 2nd Brigade accounted for 103 enemy killed and seven prisoners-of-war in 31 separate contacts.

On 25 December at 2105 hours a combat patrol from Company D, 2nd Battalion, 12th Infantry located six kilometers northeast of Trang Bang (XT552244) engaged an unknown sized enemy force. Organic weapons, artillery and light fire team accounted for five enemy killed. Five pounds of medical supplies and web gear were captured. One US soldier was wounded by enemy small arms fire. The enemy unit was identified as an element of the Trang Bang Local Force Battalion.

Company C, 2nd Battalion, 14th Infantry while on a reconnaissance mission on 29 December two kilometers east of Trung Lap (XT615219) located at 1245 hours 25 enemy bodies in 25 shallow graves approximately five days old. The enemy had been killed by artillery initiated by Duffel Bag activations and radar sightings.

CONFIDENTIAL

At 0147 hours on 30 December, snipers of the Combined Reconnaissance Intelligence Platoon, 2nd Battalion, 14th Infantry, engaged 20 enemy wearing packs 250 meters east of their position 1.5 kilometers southeast of Trung Lap (XT609207) with organic weapons, one light fire team and one flareship, killing seven of the enemy. Upon sweeping the area of contact CRIP/2-14 Inf located and destroyed one booby trapped 4.2 mortar round.

Troop B, 3rd Squadron, 4th Cavalry engaged six enemy in the Boi Loi Woods (XT489340) at 1620 hours on 31 December. Organic weapons fire, one light fire team, and two TAC air strikes resulted in all six of the enemy being killed. Four AK-47 rifles and one RPG launcher were evacuated after a sweep of the area had been made. Documents captured mention the 268 Regiment but contained no tactical information.

There were no reported shelling incidents in the 3rd Brigade area of operations during the last week of December.

On 30 December, Company B, 2nd Battalion (Mechanized), 22nd Infantry and the 604 Regional Force Company became involved in one of the largest contacts in the 3rd Brigade area of operations since the end of the Fall Campaign. At 1220 hours the combined force received small arms and automatic weapons fire from an unknown number of enemy seven kilometers southwest of Trang Bang (XT437143). Returning fire with organic weapons, five light fire teams and one artillery battery (292 rounds), US forces killed 32 of the enemy and captured one prisoner-of-war. One US soldier was wounded and one Regional Force soldier was killed by enemy fire. Contact was lost at 1740 hours. Upon sweeping the contact area, Allied forces captured and evacuated five AK-47 rifles, one light machine gun, one RPG launcher, eight 107mm rockets, five AP mines, one 20 pound AP mine, eight Claymore mines, one 30 pound Claymore mine, 1080 rounds of small arms ammunition, 300 rounds of machine gun ammunition, three RPG rounds, one 60mm mortar round, thirteen 60mm mortar fuses, thirteen hand grenades, seven AK magazines, six M-16 magazines and five pounds of web gear. Destroyed were seven AK-47 rifles, 28 bunkers and 100 miscellaneous booby traps. Documents captured after the contact identified the 267 VC/NVA Battalion, but contained no tactical information.

Eighty-seven enemy were killed and three prisoners-of-war were captured by elements of the 3rd Brigade, 9th Infantry Division during the period 25-31 December.

The largest contact took place at 2143 hours on 26 December when a combat patrol from Company C, 2nd Battalion (Mechanized), 47th Infantry engaged an unknown number of enemy four kilometers northeast of Binh Phuoc (XS634-586). Organic weapons, Claymore mines and artillery fires accounted for two enemy killed. Two AK-47 rifles were evacuated. At 0725 hours on 27 December, C/2-47 Inf (M) on a sweep of the contact area located an additional eight enemy bodies.

CONFIDENTIAL

At 1630 hours on 30 December, helicopter gunships from the 240th Assault Helicopter Company with elements of the 2nd Battalion (Mechanized), 47th Infantry engaged seven enemy 3.5 kilometers northeast of Binh Phuoc (XS627580). Engagement with rockets and mini-guns resulted in all seven of the enemy being killed. Three AK-47 rifles and 500 rounds of small arms ammunition were evacuated from the contact site.

During the month of December, division troops destroyed 424 mines and booby traps and detonated 135, resulting in 158 wounded and 18 US soldiers killed. This is an increase over the previous month as enemy tactics have placed a greater reliance on mines and booby traps as allied preemptive operations become more widespread.

The division sniper program recorded 56 kills during the month of December.

In December, the 25th Infantry Division and 3rd Brigade, 9th Infantry Division killed 1,049 enemy soldiers, captured 96 prisoners-of-war, and captured or destroyed 598 individual weapons, 35 crew served weapons and 12.3 tons of rice. The Chieu Hoi Program in the Division TAOI received 340 Hoi Chanh. In pacification efforts, the Division conducted 3,096 broadcast and 9,516 leaflet missions and treated 81,041 patients. Combined operations for the month totalled 1,455.

Duffel Bag targets engaged during the period 1-31 December 1969 resulted in 122 enemy killed. This total was credited to artillery, gunships and infantry.

During the first week of January 1970 enemy initiated activity increased slightly but remained at a moderate level. In Sub-Region 1 there were a number of contacts involving SR-1 forces as both main force and support elements became more active, possibly in preparation for future offensive operations. There was an appreciable increase in the level of enemy activity during the week. Increased movement in the An Ninh Corridor may indicate future operations against allied installations.

In the 1st Brigade area of operations there were only minor contacts with enemy units during the period 1-8 January. The largest contact developed on 1 January at 1950 hours when a combat patrol from Company D, 4th Battalion, 9th Infantry, located one kilometer south of the Renegade Woods (XT292264) engaged an estimated 20 enemy. The five man team consisting of two snipers and a three man security element spotted the enemy force approximately 400 meters south of their location. Engaging the enemy with organic weapons, three artillery batteries (86 rounds), four light fire teams, one flareship, two Night Hawk helicopters and one PSYOPS helicopter, US forces killed eight of the enemy. Though the enemy had returned fire with small arms, there were no US casualties. At 0700 hours on 2 January, the combat patrol swept the contact area and located an additional eight enemy dead, bringing the total number of known enemy killed to 16.

CONFIDENTIAL

On 4 January the 1st Brigade initiated Operation Cliff Dweller IV. This operation was to last seven days and its mission was to deny the enemy the use of Nui Ba Den as a staging area for attacks on Tay Ninh City and Allied installations in Tay Ninh Province, and as a stop-off point for enemy reinforcements coming into Tay Ninh Province from the Fishhook area of Cambodia (XT5792). (See Inclosure 11 for an After Action Report on Operation Cliff Dweller IV.)

In the 2nd Brigade area of operations there were numerous small contacts involving enemy main force and local force units. The Boi Loi Woods and Citadel areas continued to be the center of enemy activities. In 23 separate contacts, 2nd Brigade forces killed 52 enemy soldiers and captured 18 prisoners-of-war during the period 1-8 January. The most significant contact occurred on 7 January 7.5 kilometers west of Ben Suc (XT499342). At 1148 hours Troop B, 3rd Squadron, 4th Cavalry engaged an unknown number of enemy with organic weapons and helicopter gunships resulting in five enemy killed and the capture of ten prisoners-of-war. Evacuated from the contact area were nine ChiCom radios, two field phones, five pounds of TOP SECRET documents, one SOI, five AK-47 rifles and one K-54 pistol. The initial interrogation of the PWs and a readout of captured documents positively identified the unit contacted as the 1 Platoon, C20 Signal Company, 268 NVA Regiment. The following day at 1500 hours, C/3-4 Cav while on a reconnaissance mission 1.6 kilometers north-east of the contact area, located one enemy killed by artillery and evacuated one ChiCom radio, 64 batteries, one volt meter and four pounds of documents. A document readout identified the C20 Signal Company, 268 Regiment and contained a detailed plan for a sapper attack on the Trang Bang District Headquarters. Elements conducting the attack included the C11 and C12 Companies of the 3 Sapper Battalion, 268 Regiment, and the C7 Company of the 2 Battalion, 268 Regiment. The attackers are to be equipped with satchel charges, flame throwers, RPGs and one machine gun. Additional support would be provided by two anti-aircraft machine guns and "artillery" (probably mortars) from an unidentified unit. The document is undated, but it indicates that this attack is to be the start of an unspecified campaign - probably the Winter/Spring Campaign. Troop movement in War Zone "C", captured documents from SR-1 and PW interrogations from SR-3 all point to an enemy highpoint prior to TET. Trang Bang District Headquarters, a favorite enemy target in past offensives, would be a likely target for such an enemy operation. Although the enemy strengths and logistical capabilities prohibit a significant offensive, a series of small coordinated attacks could bring the enemy the publicity in the world press which is so vital to him.

Helicopter gunships of the 116th Assault Helicopter Company supporting an operation of elements of 2nd Battalion, 12th Infantry on 2 January north of Trang Bang, engaged an unknown number of enemy with automatic weapons at 1145 hours 600 meters northeast of Trang Bang (XT498194). The 3-49 ARVNs swept the contact areas and located ten enemy bodies, three AK-47 rifles, one K-54 pistol and three pounds of documents. The documents mentioned the Trang Bang (D) unit but contained no tactical information.

CONFIDENTIAL

Information revealed on 3 January, contained in a notebook captured on 20 December in the northern Citadel (XT568288), outlined the 268 Regiment's primary objectives for the second phase of the Winter Campaign. The unit's primary mission is to frustrate the pacification program, attack boats on the Saigon River and destroy land-clearing teams. The regiment is tasked with regaining the combat initiative in Trang Bang and Cu Chi Districts, with the key objective being an area where rice is abundant. It is possible that the 268 Regiment is effecting coordination with sub-regional support elements for an offensive which is probably scheduled for the month of January.

Documents captured on 6 January by Company B, 2nd Battalion, 12th Infantry four kilometers southwest of Trung Lap (XT540205) included a draft dated 15 November summarizing the results of a political indoctrination session on COSVN Resolution 9 conducted by SR-1 and its subordinate district and village party committees. Sessions included: (1) assess the enemy and allied situation; (2) implement the five strategic provisions set forth in Resolution 9; and (3) to eliminate weaknesses demonstrated by SR-1 personnel. The most significant examples cited were the various declines in political movements; continuous passive status of local areas; inability to conduct ground attacks on Saigon, Hue or Da Nang. Some members conceded guerrilla warfare has required too long a struggle, while other members have become uncertain of COSVN's guidelines. Because of this, combatants and party members have lost faith in the revolutionary capability or goals, as well as the sense of responsibility and have become undisciplined.

On New Year's Day, Vice President Spiro T. Agnew arrived at Cu Chi, Vietnam and made an inspection and review of Fire Support Base Patton, the forward headquarters of 2nd Battalion, 14th Infantry "Golden Dragons". Both Vice President Agnew and Major General Hollis congratulated the 2-14 Inf on their high state of preparedness and excellent record as a maneuver battalion of the 25th Infantry Division.

In the 3rd Brigade area of operations there was an increase in enemy activity as demonstrated by 42 enemy killed in five separate contacts. During the period 1-8 January there were five reported shelling incidents in the 3rd Brigade area of operations. The largest attack by fire took place at 0210 hours on 8 January. Company C, 2nd Battalion, 27th Infantry at Patrol Base Kotrc (XT358145) observed six rounds of 120mm mortar fire impact outside the wire. At 0437 hours, two unidentified helicopters were spotted by MPQ/4 radar at PB Kotrc, as well as visually. A light fire team and flareship were scrambled but the sighting was lost at 0525 hours before contact could be achieved.

On 6 January at 1600 hours a sniper team from Company D, 2nd Battalion, 27th Infantry located eleven kilometers southwest of Go Dau Ha (XT315175) received sniper fire from an unknown number of enemy. Returning fire with organic weapons and helicopter gunships, 17 of the enemy were killed. On a sweep of the contact area at 1630 hours on 7 January, the 127 Regional Force Company located an additional eight enemy dead, bringing the total number of enemy killed to 25.

CONFIDENTIAL

In the 3rd Brigade, 9th Infantry Division area of operations, Division soldiers accounted for 54 enemy killed in 19 separate contacts. On 7 January at 2025 hours, Company C, 2nd Battalion (Mechanized), 47th Infantry engaged an unknown number of enemy with organic weapons and artillery four kilometers northwest of Binh Phuoc (XS580572). Fourteen enemy soldiers were killed, and two AK-47 rifles and one SKS rifle were evacuated. One US soldier was wounded by enemy small arms fire.

At 2045 hours on 2 January, Company B, 6th Battalion, 31st Infantry, eight kilometers southeast of the "Parrot's Beak" (XS352865), engaged four enemy with helicopter gunships and artillery resulting in four enemy killed. Three sampans were destroyed, three AK-47 rifles were evacuated. Four and one-half hours later B/6-31 Inf engaged an unknown sized enemy force at the same location with helicopter gunships and organic weapons resulting in an additional three enemy killed. Three AK-47 rifles and 4 pound of documents were evacuated.

Team 17, Company E, 75th Infantry (Ranger) engaged 15-20 enemy 6.5 kilometers northeast of Tan An (XS603685) at 2005 hours on 5 January. Nine enemy were killed by engagement with organic weapons and supporting fires from a light fire team. Though the enemy returned fire with small arms there were no US casualties.

As the second week of January (9-16 January) ended, enemy forces within the Division TAOI continued to avoid significant contact with Allied forces. The majority of contacts continued to be friendly initiated as rear service elements continued to resupply main force units in their preparation for the further postponed Winter/Spring Campaign. Allied preemptive operations continued to force enemy elements to widely disperse, further prohibiting the enemy from staging large coordinated attacks throughout the TAOI.

On 11 January information was revealed from an interview with two Hoi Chanh (Tran Minh Dao and Vo Ngoc Phan) concerning possible VC/NVA military activities during the upcoming TET. Both Dao and Phan agreed that the heaviest military activities would occur in I, II and III Corps. In both I and II Corps, replacements would be easily obtained, infiltrating south from North Vietnam and could quickly reinforce operational units. The VC/NVA will also place emphasis on IV Corps because it is a vast food producing region and it offers the VC/NVA an excellent food supply. In addition, because of the withdrawal of US forces from IV Corps, the VC/NVA may attempt to undermine the local populace's confidence in the GVN. In II Corps, both Dao and Phan believe that military action during TET would be characterized by limited sapper attacks. Saigon is still considered a prime military target, however attempts to infiltrate the city would probably be limited to sapper units. Dao believes larger attacks will occur in Tay Ninh, Binh Long and Phuoc Long Provinces as the VC/NVA have relatively secure base areas in these Provinces. As to the possibility that the VC/NVA will initiate no offensive until this coming summer, both Dao and Phan agreed that while this

CONFIDENTIAL

was possible, it does not seem probable. Dao seemed to think that the failure to attempt an offensive would create morale problems within VC/NVA units.

Activity within the 1st Brigade area of operations increased significantly during the period 9-16 January. There were two major contacts in Tay Ninh Province. On 11 January Operation Cliff Dweller IV (See Inclosure) was ended. The final results from this seven day operation on the north-eastern slope of Nui Ba Den (XT276600) were 155 enemy killed, three US soldiers killed and eight US soldiers seriously wounded.

On 9 January at 0915 hours, Companies A and B, 4th Battalion (Mechanized), 23rd Infantry with eight Regional Force Companies (157, 309, 315, 766, 767, 872, 905 and 930) engaged an estimated 100 enemy in the open eight kilometers south of Cau Khoi (XT3436). Engagement with organic weapons, two light fire teams, two flareships, TAC air strikes and artillery resulting in 32 enemy killed. One US soldier and five RF soldiers were wounded when the enemy returned fire with small arms, automatic weapons and RPGs. Two APCs received light damage from enemy fires. On a sweep of the contact area the following day, A,B/4-23 Inf (M) located 60 fighting positions and 60 60mm mortar rounds, all of which were destroyed. At 1415 hours US ground forces located 63 enemy bodies and evacuated 25 rifle grenades, three AK-47 rifles, two RPG launchers, 45 RPG rounds, five pounds of web gear, 60 82mm mortar rounds, 900 rounds of small arms ammunition, 40 hand grenades and $\frac{1}{2}$ pound of documents. Destroyed were 10 RPG rounds and 11 hand grenades. The total number of enemy killed accredited to Allied forces for the previous day's contact was 89. Documents found on enemy bodies identified the D14 Battalion of Tay Ninh Province. Later evidence revealed that two companies of the D14 Battalion and the C33 Go Dau Ha (D) (VC) Local Force Company were the units contacted.

During the period 9-16 January there were four reported shelling incidents in the 1st Brigade AO. The largest shelling occurred at 0145 hours on 13 January when Tay Ninh Base Camp (XT1652) received 28 rounds of 82mm mortar fire. Company D, 4th Battalion, 9th Infantry at the Ben Cau Regional Force Outpost (XT234305) received 24 rounds of 60mm mortar fire at 2040 hours on 9 January and 10 rounds of 60mm mortar fire at 1823 hours on 14 January. No US casualties were sustained in any of the shelling incidents.

In the 2nd Brigade area of operations for the week of 9-16 January, 25 separate contacts resulted in 48 enemy killed and nine prisoners-of-war. Twenty-eight of the enemy were killed by helicopter gunships of the 116th Assault Helicopter Company in support of operations by 2d Brigade maneuver battalions. The area of heaviest contact continued to be in the Citadel/Trang Bang area and the Boi Loi Woods, with rear service activities being the primary concern of both enemy main and local force units. One shelling incident was reported during this period. A night defensive position of

40

CONFIDENTIAL

CONFIDENTIAL

Troop B, 3rd Squadron, 4th Cavalry located in the western lower Boi Loi Woods (XT488312) received three rounds of RPG fire at 2300 hours on 9 January resulting in two US soldiers wounded.

On 11 January, acting on intelligence developed by Counterintelligence Section, 25th Military Intelligence Company, elements of Company C, 1st Battalion (Mechanized), 5th Infantry and 25th MIC exploiting two Hoi Chanh who led US troops to a carefully concealed tunnel four kilometers southwest of Trung Lap (XT543206). One enemy soldier was induced to rally, and revealed the presence of five others in the tunnel. When the five enemy soldiers refused to surrender, the tunnel was destroyed with a 40 pound shape charge killing all five of the enemy. Two AK-47 rifles, two K54 pistols, four US hand grenades, and two pounds of documents were captured. Two M79 grenade launchers, one AK-47 rifle and one US compass and four tunnels were destroyed. The two Hoi Chanh stated that one of the dead enemy was Major Tu Vinh, Security Chief of SR-1. When shown pictures of the dead, Vo Ngoc Phan, former NVA Major and Assistant Chief of Staff of SR-1, identified one of the dead as Tu Vinh and stated that he held the rank of Major. 25th Infantry Division Order of Battle files hold Tu Vinh as Secretary, Administrative Sub-Section, Security Section of Headquarters, Sub-Region 1 Political Section as of July 1969.

Interrogation of a prisoner-of-war captured by Company C, 2nd Battalion, 12th Infantry on 13 January four kilometers northwest of Trung Lap (XT564245) revealed that he was a member of the Men's Association of Cu Chi (D). The PW mentioned a meeting he had with the Commanding Officer of the 268 Regiment (Hoang Thanh) about 11 days prior to his capture. The commander told the PW that the VC would open an offensive before Tet. The CO also said that a sapper reconnaissance squad had penetrated the outer defenses of a US base at Lao Tao (Fire Support Base Patton) on several occasions to observe defensive activities. In the near future, according to the CO, a sapper attack would be launched against the base using sappers, but that they were waiting for the availability of fire support before the attack would be launched. 25th Infantry Division Order of Battle related documents captured on 20 December in the northern Citadel area which revealed that the 268 Regiment had planned a raid against a US position, possibly FSB Patton. The documents, dated 9 December, revealed that the raid would be on D-Day plus four. No information was available on the exact date of D-Day.

A 2nd Brigade Aviation LOH with the Scout Platoon, 1st Battalion (Mechanized), 5th Infantry and 1-49 ARVNs at 0935 hours on 14 January exploiting Hoi Chanh information four kilometers northwest of Trung Lap (XT568255) engaged an unknown number of enemy with organic weapons and helicopter gunships killing eight enemy. Evacuated from the contact area were three AK-47 rifles, seven pounds of web gear and five pounds of documents. US forces destroyed 46 rounds of RPG ammunition, ten AK-47 magazines, five booby trapped 105mm rounds, four booby trapped hand grenades and nine bunkers.

CONFIDENTIAL

On 17 January a Cobra gunship from Troop D, 3rd Squadron, 4th Cavalry observed an unidentified helicopter flying eight kilometers west-southwest of Tra Cu (XS3992). Contact was lost when the unidentified helicopter crossed the Cambodian border on a northerly heading.

Enemy activity continued on a moderate level in the 3rd Brigade area of operations. No significant contacts occurred during the week. Five separate contacts resulted in five enemy killed and the capture of one prisoner-of-war. Two shelling incidents were reported in the 3rd Brigade AO, neither causing any US casualties.

The heaviest activity of the week occurred in the area of operations of the 3rd Brigade, 9th Infantry Division. In 21 separate contacts 116 enemy were killed and three prisoners-of-war captured. The largest contact occurred at 0830 hours on 12 January when Team 17, Company E, 75th Infantry (Ranger), Company D and Reconnaissance Platoon, 6th Battalion, 31st Infantry with air support from Troop B, 3rd Squadron, 17th Air Cavalry engaged an unknown sized enemy force seven kilometers southeast of Tan An (XS6060). Engagement with organic weapons, three light fire teams, three artillery batteries (2116 rounds) and three TAC air strikes resulted in 12 enemy killed. The enemy returned the fire with small arms, automatic weapons and a command detonated mine, killing one US soldier and wounding seven others. One LOH received light damage, another received heavy damage by heavy enemy ground fires. Sweeping the contact area US forces captured two prisoners-of-war. One AK-47 rifle, one pound of documents and one K54 pistol were evacuated and 21 bunkers were destroyed. At 1315 hours on 13 January A, Rcn/6-31 Inf in a sweep of the previous day's contact area located an additional 26 enemy KIA to bring the total number of enemy killed to 38. Interrogation of one of the PWs identified the K7 Sapper Battalion, 1 NVA Regiment. This is the first positive identification of the unit as a new battalion of the 1 NVA Regiment, although previous documents and PWs have made reference to the battalion. According to the PW, the C25B Company is located northwest of Binh Phuoc and plans to conduct a sapper attack against the 2nd Battalion (Mechanized), 47th Infantry's base camp at Binh Phuoc (XS6055) sometime during January. The source located the C25A Sapper Company of the 1 NVA Regiment northeast of Binh Phuoc. However, he claimed that the company had been practically eliminated as a result of recent contacts with Allied forces. The PW's statement tends to confirm information provided by the Assistant Chief of Staff of the 1 NVA Regiment's 3 Battalion, captured on 8 January.

At 1145 hours on 11 January, helicopter gunships of the 118th Assault Helicopter Company with elements of 2nd Battalion, 60th Infantry, gunships of Troop B, 3rd Squadron, 17th Air Cavalry and the 478 Regional Force Company engaged an unknown sized enemy force eight kilometers northeast of Tan An (XS626683). Small arms, automatic weapons and helicopter gunships accounted for 17 enemy killed in the contact which lasted approximately four hours. Eight AK-47 rifles, one RPG launcher and one

42

CONFIDENTIAL

CONFIDENTIAL

complete 82mm mortar were evacuated. Eight rounds of RPG ammunition were destroyed.

Company B, 2nd Battalion (Mechanized), 47th Infantry with 2-50 ARVNs engaged an unknown number of enemy seven kilometers southeast of Tan An (XS599602) at 2010 hours on 14 January. The enemy force returned with small arms fire but there were no US casualties. Seven of the enemy were killed. At 0800 hours the following day, B/2-47 Inf (M) located an additional three enemy killed while on a sweep of the contact area.

Main and local force activity continued at a moderate level during the 3rd week of January (17-24 January). The Citadel/Trang Bang area continued as the center of enemy activity, particularly as enemy elements worked in conjunction with rear service units procuring and moving supplies. The movement of supplies and troops by the enemy throughout the Division's TAOI suggests that the highpoint of the Winter/Spring Campaign that was to come in January may have been further postponed by Allied preemptive operations. Attacks by fire continue to be the major enemy tactic at this time. Probing and small sapper attacks have been on the increase, but this is an expected move by the enemy as he prepares for his Winter/Spring Campaign.

In the 1st Brigade area of operations there were four reported shelling incidents. At 0220 hours on 21 January Tay Ninh Base Camp (XT1651) received 25 rounds of 82mm mortar fire. No US casualties were sustained. Two night defensive positions of elements of Company D, 4th Battalion, 9th Infantry received attacks by fire at 2210 hours on 23 January. A position two kilometers southwest of the Renegade Woods (XT258292) received seven rounds of 82mm mortar fire resulting in no US casualties. The second position, three kilometers southeast of the Straight Edge Woods (XT234306) received 20 rounds of 82mm mortar fire resulting in one US soldier being killed. Both attacks by fire originated from a point three kilometers northwest of the Angel's Wing (XT2128).

Two significant contacts developed during the 3rd week of January within the 1st Brigade AO. On the afternoon of 23 January (1715 hours), helicopter gunships of Troop D, 3rd Squadron, 4th Cavalry and tanks of Headquarters Company combat element of the 2nd Battalion, 34th Armor engaged an unknown number of enemy in the rock slide area of the northeastern slope of Nui Ba Den (XT275600). Automatic weapons, main tank guns, helicopter gunships, TAC air strikes and artillery engagement resulted in 12 enemy killed. The enemy returned fire with small arms but there were no US casualties.

At 1420 hours on 24 January, Company B, 3rd Battalion, 22nd Infantry engaged 25-50 enemy two kilometers east of the Cambodian Border (WT973-491). Organic weapons, two light fire teams and one artillery battery (237 rounds) accounted for 22 enemy killed. Sixteen of the enemy were

CONFIDENTIAL

CONFIDENTIAL

killed by helicopter gunships of the 187th Assault Helicopter Company. The remaining enemy withdrew into Cambodia. There were no US casualties, and moderate damage was caused to two UH1H helicopters by heavy enemy small arms fire.

Company D, 4th Battalion, 9th Infantry located a cache in four separate holes eight kilometers west of Go Dau Ha (XT311246) at 1245 hours on 20 January. Evacuated were 211 ChiCom hand grenades, 57 AT mines, ten rounds of 82mm mortar ammunition, five homemade AP mines, nine cans of 82mm mortar detonators, 3600 rounds of small arms ammunition and one 2.75 inch rocket warhead.

Information revealed on 24 January concerning three prisoners-of-war captured near Phuoc Tan Outpost (XT005440) by Special Forces elements on 18 January identified the PWs as battalion and company level cadre of the Field Research Section of COSVN's Militia Directorate. Interrogation has revealed that the PW's mission was to conduct reconnaissance of potential targets for local force elements. The identification of three relatively high-ranking cadre southwest of Tay Ninh serves to reinforce previous indications of a possible renewed interest in the area by Communist forces.

In the 2nd Brigade area of operations for the period 17-24 January there were 15 contacts resulting in 37 enemy killed and four prisoners-of-war. The 2nd Battalion, 12th Infantry had two contacts on the evening of 22-23 January resulting in 14 enemy KIA. At 1946 hours on 22 January, Company D engaged 12 enemy with organic weapons, one artillery battery (31 rounds) and one light fire team six kilometers northwest of Trung Lap (XT551259) resulting in seven enemy killed and the capture of two AK-47 rifles. A combat patrol from Company A located eight kilometers northeast of Go Dau Ha (XT4727) engaged an unknown number of enemy at 0020 hours on 23 January killing seven of the enemy. Five AK-47 rifles and 3/4 pound of documents were evacuated from the contact area.

Five shelling incidents were reported in the 2nd Brigade area of operations for the week 17-24 January. Four of the attacks by fire were directed against night defensive positions of elements of 3rd Squadron, 4th Cavalry operating in the Boi Loi Woods. The attacks were usually only one or two rounds of RPG fire, harassment rather than a purposeful attack by fire. No US casualties were sustained in any of these shellings.

Company C, 1st Battalion (Mechanized), 5th Infantry with 1st Company, 1-49 AAVNs, three kilometers northwest of Trung Lap (XT574249) located a cache in a tunnel at 0816 hours on 22 January. Evacuated were three TA-312 telephones, three TA-1 telephones, one handset, one walkie-talkie, one NVA protective mask, one ChiCom .30 caliber machine gun, one US carbine, three AK-47 rifles, one M60 machine gun, one Browning .30 caliber machine gun, one RPD machine gun, eight SKS rifles, one 60mm mortar with bipod and nine RPG rounds. Destroyed were one ChiCom 25 pound claymore mine,

CONFIDENTIAL

14 bangalore torpedoes, one US hand grenade and 11 RPG rounds.

Activity increased slightly in the 3rd Brigade AO as enemy elements concerned themselves with providing security for and movement of supplies into the sub-regions. In six separate contacts, 3rd Brigade soldiers killed 12 enemy soldiers and captured five prisoners-of-war.

Company C, 2nd Battalion (Mechanized), 22nd Infantry at 1130 hours on 18 January, with the Combined Reconnaissance Intelligence Platoon, 2nd Battalion, 27th Infantry, National Police and 139 Regional Force Company, operating three kilometers north of Bao Trai (XT5508) captured two prisoners-of-war and uncovered a bunker complex. Destroyed were eight tunnels, four 82mm mortar charges, ten RPG rounds and two blasting caps. Evacuated were one 82mm mortar sight, one Russian light machine gun, one AK-47 rifle and five pounds of medical supplies. While sweeping the complex site, C/2-22 Inf (M) engaged three enemy with organic weapons killing all of the enemy soldiers. Also, one booby trapped AP mine was detonated resulting in the wounding of ten US soldiers and two RF soldiers. Two and one-half hours later (1400 hours), C/2-22 Inf (M) engaged two enemy two kilometers south-east of the earlier contact (XT555056) with hand grenades resulting in two enemy KIA. One-quarter pound of documents were removed from the dead enemy and evacuated.

The 3rd Brigade elements were successful in forcing the enemy to postpone or abandon offensive actions by destruction of vital enemy supplies. On 19 January at 1120 hours, Company D, 2nd Battalion, 27th Infantry located a cache four kilometers southwest of Go Dau Ha (XT359222) and evacuated 209 60mm mortar rounds, 42 82mm mortar rounds, nine 120mm mortar rounds, 22 57mm recoilless rifle rounds, 35 75mm recoilless rifle rounds, five hand grenades, 31,350 small arms rounds and 648 time detonating fuses for 82mm mortar rounds.

On 20 January a 3rd Brigade Cavalry element with the 773 Regional Force Company reacting to 25th Military Intelligence Company intelligence information, six kilometers southwest of Cu Chi (XT577092), engaged 13 enemy with small arms and automatic weapons at 1610 hours. Five prisoners-of-war were captured along with one K54 pistol, two AK-47 rifles and two hand grenades. Contact was lost at 1730 hours. There were no US casualties.

In the 3rd Brigade, 9th Infantry Division area of operations enemy elements continued to be quite active. In 32 separate contacts, 3-9 Inf Div soldiers killed 70 enemy and captured five prisoners-of-war. The most significant contact developed at 1000 hours on 19 January when Companies A and D, 2nd Battalion, 60th Infantry engaged an unknown number of enemy with organic weapons, one light fire team, one TAC air strike and two artillery batteries (191 rounds), three kilometers northwest of Ap Tan Thuan (XS6464). Eleven of the enemy were killed. While sweeping, ground troops detonated one booby trapped hand grenade resulting in three

CONFIDENTIAL

US wounded. One bunker was destroyed by US troops and one AK-47 was evacuated.

Company A, 5th Battalion, 60th Infantry and Troop B, 3rd Squadron, 17th Air Cavalry engaged an unknown number of enemy at 1135 hours on 21 January three kilometers southeast of Ben Luc (XS638738). Engagement with organic weapons, helicopter gunships, TAC air strikes and artillery resulted in seven enemy killed. The enemy returned fire with small arms and automatic weapons killing one US soldier and wounding another.

The last week of January (25-31 January) was marked by a continued low to moderate level of enemy activity. Local force units and main force units both appeared to be concentrating on the procurement and transportation of supplies in preparation for the anticipated Tet holidays highpoint. Several incidents of Communists collecting taxes were reported this week in Tay Ninh Province for which local force units were responsible. The lull in the 9 VC/NVA Division's activities may be due to their preparation for a series of operations against fire support bases in War Zone C.

On 26 January a liaison team from the Americal Division arrived at Cu Chi. This party, composed of officers from the G2/3/5 sections, signal, and fire support coordination facilities, met with their opposite numbers from the 25th Infantry Division for two days to discuss techniques and innovations. The team departed at 1700 hours on 27 January.

During the period 25-31 January there were five reported incidents of shelling in the 1st Brigade area of operations. At 1045 hours on 26 January Tay Ninh Base Camp (XT1651) received ten rounds of 107mm rocket fire and nine of 122mm rocket fire. This attack wounded four US soldiers and caused heavy damage to a light observation helicopter. On 27 January the 3rd Battalion, 22nd Infantry at Fire Support Base Washington (XT146568) observed 26 rounds of 120mm mortar fire impact outside the perimeter at 0005 hours.

There were seven scattered contacts by Brigade units during the week resulting in 14 enemy KIA. However, on 31 January at 1000 hours a 25th Aviation Battalion UH1H on an Airborne Personnel Detector mission was fired on by an unknown number of enemy with automatic weapons in War Zone C, nine kilometers northeast of Trai Bi (XT155715). The ship was flying at an altitude of 100 feet at 80 knots when it was hit. The helicopter was destroyed, and all seven men aboard were killed when it crashed and burned.

There were no reported shelling incidents in the 2nd Brigade area of operations, and most of the contacts were in the Citadel/Boi Loi Woods area. There were 18 contacts resulting in 24 enemy killed and 11 prisoners-of-war captured at a cost of nine US WIA. On 26 January Troop A, 3rd Squadron, 4th Cavalry on a sweep through the Boi Loi Woods uncovered a weapons-cache at 1150 hours. From two bunkers seven kilometers west-southwest of Ben Suc

CONFIDENTIAL

(XT508343) they evacuated five Browning Automatic Rifles, two ChiCom light machine guns, three Russian machine guns, one Springfield rifle, 52 CKC rifles, 200,000 rounds of small arms ammunition, 20 122mm rockets, 43 107mm rockets, seven rounds of 75mm recoilless rifle ammunition, six rounds of 57mm recoilless rifle ammunition, 25 RPG rounds, five 82mm mortar rounds and ten rocket grenades, and destroyed 40 ChiCom grenades and 80 pounds of ChiCom TNT. At 1415 hours they located three enemy KIA in graves six kilometers west of Ben Suc (XT521351). At 1500 hours they engaged two enemy who were attempting to evade them with small arms and automatic weapons fire seven kilometers west of Ben Suc (XT510356). Both enemy were wounded and captured. Interrogation revealed that the prisoners were newly arrived replacements for 1 Company, 1 Battalion, 268 Regiment.

Troop A, 3rd Squadron, 4th Cavalry engaged two enemy hiding in a hole eight kilometers west of Ben Suc (XT499329) with a hand grenade at 1100 hours on 27 January. Both were captured, and the one man who was wounded evacuated to the 12th Evacuation Hospital in Cu Chi. In addition there were four enemy KIA. At 1155 hours a pressure-type mine was detonated in the same area resulting in two US KIA and one WIA. At the same time an unknown number of enemy were engaged seven kilometers west of Ben Suc (XT507350) with organic weapons and a light fire team with unknown results. Subsequent interrogation of the wounded prisoner revealed that he was Hai Khoi, the Commanding Officer of the 3 Battalion, 268 Regiment. He stated that he had been wounded on or about 20 November 1969 and had been waiting at his place of capture ever since then for evacuation.

Company C, 2nd Battalion, 12th Infantry had the only other significant contact in the Brigade area on 30 January. Operating in the Citadel region five kilometers northeast of Trang Bang (XT502216) the unit captured two PWs at 1458 hours. At 1620 hours approximately 600 meters further north (XT503210) they received small arms and rocket grenade fire from an unknown number of enemy, and returned it with organic weapons. Casualties in this contact were six US WIA and two enemy KIA.

Effective 1600 hours 25 January responsibility for the defense of Cu Chi Base Camp was changed from the 2nd Brigade to the 3rd Brigade. At the same time the 3rd Brigade took over operational control of the 2nd Battalion, 14th Infantry, less Company A, from the 2nd Brigade.

Within the 3rd Brigade area of operations there were seven shelling incidents resulting from the planned enemy pre-Tet attacks by fire on patrol and fire support bases blocking the infiltration routes in Sub-Region 2. On 29 January the 2nd Battalion, 27th Infantry at Patrol Base Kotrc (XT358145) received five separate attacks. Between 0035 hours and 0220 hours one round of 82mm mortar fire and nine rounds of 120mm mortar fire impacted outside the perimeter with negative damage or casualties. Radar directed counterbattery fire was returned with unknown effect. The final volley of two rounds of unknown high explosive ammunition struck outside the wire with no damage at 1850 hours.

CONFIDENTIAL

During the week of 25-31 January the Brigade had only two contacts, resulting in one enemy KIA. At 1455 hours on 26 January Cu Chi Base Camp (XT649168) had one man on day bunker guard on Bunker 54 killed by suspected enemy sniper fire.

There was only one minor shelling incident in the 3rd Brigade, 9th Infantry Division area of operations. However, there were 20 contacts resulting in 46 enemy killed, one Hoi Chanh received, one US KIA and two US WIA. On 27 January at 0710 hours, Company B, 6th Battalion, 31st Infantry 13 kilometers northeast of Tan An (XS716648) engaged an estimated five enemy with small arms, automatic weapons, artillery and tactical air strikes resulting in one enemy KIA. A further sweep of the area between 1015 and 1100 hours revealed the bodies of ten more enemy KIA, five each being credited to artillery and the Air Force. Three pounds of documents and 200 rounds of small arms ammunition were evacuated.

On 25 January at 1450 hours a UH1C of the 118th Assault Helicopter Company supporting Company C, 2nd Battalion, 60th Infantry on a combat assault eight kilometers northeast of Tan An (XS618694) received one round of suspected RPG fire. At the time the aircraft was flying at an altitude of 150 feet at a speed of 85 knots, and did not return the fire. The crew chief was killed and the pilot wounded. The moderately damaged ship was evacuated to Tan Tru at 1514 hours and further evacuated to Tan An at 1750 hours.

During the month of January Division troops destroyed 342 mines and booby traps and detonated 113, resulting in nine US soldiers killed and 172 wounded. The Division sniper program recorded a total of 48 kills with a noticeable lull during the last week of the month when only one was recorded.

In January the 25th Infantry Division and 3rd Brigade, 9th Infantry Division killed 1,010 enemy soldiers, captured 67 prisoners-of-war, and captured or destroyed 288 individual weapons, 22 crew-served weapons and 5.52 tons of rice. The Chieu Hoi Program in the Division TAOI received 22 Hoi Chanh. In pacification efforts, the Division conducted 3,311 broadcast and 13,490 leaflet missions and treated 87,253 patients. Combined operations for the month totaled 1,590.

During the quarter from 1 November 1969 to 31 January 1970 the 25th Infantry Division and 3rd Brigade, 9th Infantry Division successfully forced the enemy to continually postpone his Winter/Spring offensive. Through aggressive preemptive operations enemy elements were forced to continue functioning in small units unable to mount a significant offensive. During this period 25th Infantry Division operations (to include 3rd Brigade, 9th Infantry Division) accounted for 3,478 enemy eliminated, including enemy soldiers killed, captured, and rallying (Hoi Chanh) to the GVN.

CONFIDENTIAL

CONFIDENTIAL

Because the enemy had sustained such heavy losses during his Summer and Fall Campaigns, he changed his tactics in order to more successfully combat Allied operations. Many enemy maneuver elements underwent extensive sapper training with the purpose of using small groups of sappers to inflict heavy losses on men and equipment within the Division's TAOI. The enemy also reverted to shellings and attacks by fire to achieve this same purpose. Though the enemy had planned to use these new tactics to regain the momentum he had lost since Tet 1968, 25th Infantry Division operations continued to disrupt all enemy plans. Wherever the enemy attempted to operate he was under constant pressure from snipers, combat patrols, small unit operations and electronic surveillance. Furthermore, great strides have been made in the pacification program. The enemy has found himself more alienated from the people than at any other period during the war. Also, the tenacity and professionalism of the South Vietnamese soldier has greatly improved through combined operations with US forces and the ability to successfully conduct their own operations.

With the increased Vietnamization of the war, 25th Infantry Division forces were able to maintain a posture of "protective reaction" as the mode of operations within the Division's TAOI. Protective reaction refers to the type of combat operations used by allied commanders against Communist forces in the Republic of Vietnam to provide for the security of his unit, his tactical area of operations and the Vietnamese people.

This is accomplished primarily by small unit reconnaissance patrols to locate the enemy, disrupt his movements and find his caches of arms, ammunition and rations. Large scale unit operations have proved unnecessary and unprofitable as the enemy forces are broken down into smaller and smaller units. Division forces conducted an active or mobile defense of the large inhabited areas to protect the people and Division units and installations.

The effect of these small unit reconnaissance operations has been to preempt the massing of enemy forces, destroy those forces which are contacted, and forced the enemy into his Cambodian sanctuaries or deep jungles away from the major population centers in III Corps Tactical Zone. The results of these operations have been to inflict serious personnel losses on the enemy and to disrupt his supply activities. They have disorganized the enemy's usually scrupulous attack planning, imposed heavy personnel losses on the enemy while reducing friendly casualties, and deprived the enemy of the arms and supplies needed to sustain his attacks. The enemy units are not only being cut down in size, but are losing their experienced leaders.

The 1st Brigade has preempted all enemy attempts to initiate an offensive in Tay Ninh Province, prevented the enemy from freely using the cave-

CONFIDENTIAL

strewn slopes of Nui Ba Den as a refuge and stop-over point for infiltration groups, and successfully restricted enemy infiltration into Tay Ninh Province from Cambodia. The enemy was forced to resort to attacks by fire as his primary offensive tactic.

The 2nd Brigade continued to disrupt local and main force operations in the Trang Bang-Citadel area, Boi Loi Woods and Ho Bo Woods. As the dry season progressed, Rome Plow operations in these areas forced the enemy to further disperse his forces to prevent complete annihilation of his offensive capabilities. Effective military and political power of Sub-Region 1 forces were seriously reduced by the small unit tactics of Allied forces in the 2nd Brigade area of operations. An additional ARVN battalion was moved into the 2nd Brigade AO to increase Allied effectiveness in this area. Preemptive operations cut deeply into the enemy's reserves of rations, munitions and supplies. Without these vital supplies the enemy was unable to coordinate an effective offensive in the 2nd Brigade area of operations. Close coordination between 2nd Brigade maneuver elements and Division intelligence sources caused a further breakdown of the Viet Cong Infrastructure in Hau Nghia Province. Rapid reaction to exploitable intelligence continued to force local guerrillas to maintain their ineffective posture.

The combat effectiveness of 3rd Brigade was significantly strengthened by the move of 2nd Battalion (Mechanized), 22nd Infantry from the 1st to 3rd Brigade AO. With the advent of the dry season, enemy infiltration and offensive activities were on an increase in the 3rd Brigade AO. The move of an additional maneuver battalion to combat Sub-Region 2 forces has seriously restricted his use of the An Ninh Corridor as an infiltration route, forced main force units taking sanctuary in Cambodia to remain there and disrupted local force activities through increased use of small unit tactics, combat patrols and snipers.

Operations of 3rd Brigade, 9th Infantry Division accounted for 1082 enemy KIA, forced Sub-Region 3 units to operate in dispersed groups to escape allied detection, disrupted Sub-Region 6 local and main force plans for attacks on Saigon and greatly expanded the pacification program in Long An Province. With United States Naval forces, 3-9 Inf Div units seriously disrupted the enemy's ability to operate along canals and rivers within Long An Province, prevented enemy reinforcements of men and supplies to local guerrilla forces and reduced the effectiveness of the Viet Cong Infrastructure by continuous monitoring of the enemy's routes of movement.

b. (C) Personnel:

(1) During the months of November and December 1969 and January 1970, the aggregate division personnel strength averaged 17,626 of 17,624 authorized or 100%. Enlisted personnel strength averaged for this period 16,284 of 16,324 authorized, or 99.8%, while officer personnel strength for the period

CONFIDENTIAL

averaged 1,342 of 1,295 authorized or 103.5%. Personnel shortages continue to exist in infantry captains and field artillery lieutenants and noncommissioned officers in the grade of E6 through E9 in 11B, 11C, 12B, 17B, 17K, 31G, 63A, 63C, 76P, 76Y, 76Z, and 94B MS.

(2) During the period 1 November 1969 through 31 January 1970, the division had 71 KIA's (11 officers and 60 EM), and 1,037 WIA's (85 officers and 952 EM), excluding OPCON units. There were 22 nonbattle deaths, 107 nonbattle injuries and 0 missing in action. Officer gains for the period numbered 513 while administrative officer losses were 479. EM gains were 6,272 while administrative EM losses totaled 5848.

(3) Principal Command and Staff: The identification of the principal command and staff personnel within the 25th Infantry Division for the reporting period is as follows: wd HQ, DA

c. (C) Intelligence:

(1) Summary of Enemy Activity.

(a) During the month of November the enemy activities in the 25th Infantry Division TAOI were light to moderate. Reduced levels of activity can be attributed to the reduced flow of logistics and replacement personnel to VC/NVA units within the TAOI. Principle areas of enemy activity during the month were Tay Ninh Base Camp, Citadel/Trang Bang area, lower Boi Loi/Ho Bo Woods areas, and the An Ninh Corridor. Enemy activity increased during the week of 2-9 November, but fell off sharply for the remainder of the month.

(b) During the month of December the enemy activities in the 25th Infantry Division TAOI remained at a moderate level. The reduced level of activity

can be attributed mainly to the main force units breaking down into squad and platoon sized units in order to avoid contact while being resupplied by rear service elements. Complementing this avoidance of contact was a significant increase in mining activity during the month. Principle areas of enemy activity during the month of December were the Citadel/Trang Bang area, Ho Bo Woods and Boi Loi Woods areas, and in Long An Province along the Vam Co Dong.

(c) Enemy initiated activity during the month of January in the 25th Infantry Division TAOI remained at a moderate level with an increase in activity during the last week of the month. This increase in activity may have concluded the Fall-Winter Campaign. Offensive activity during the month consisted mostly of limited attacks by fire on fire support bases and patrol bases, as main force units continued their avoidance of any major contacts. Primary emphasis continued to be placed on the reconstruction of logistical and personnel bases. Principle areas of enemy activity during January were in the Citadel/Trang Bang area, east of the Angel's Wing, in Long An Province along the Vam Co Dong, on Nui Ba Den, and in the vicinity of Tay Ninh. The most prevalent activity of the enemy during the whole quarter has been the resupply of food and ammunition, and possibly some infiltration of personnel during the latter part of January, with the increase of attacks by fire in late January.

(2) Operational Report for Source/Liaison Target Exploitation Operations.

(a) During the quarter the Source/Liaison Target Exploitation Operations have accounted for 45 VC/NVA KIA, 4 VCI KIA, 17 VC/NVA PW, 3 VCI PW, and 11 other detainees. In addition, 28 small arms, 2 crew-served weapons, 24 pounds of documents, 26 pounds of explosives ranging in size from hand grenades to 155mm artillery rounds, and 12,510 pounds of rice were evacuated or destroyed.

(b) During this period the following members of the Viet Cong Infrastructure have been neutralized:

Nam Bo - Security Chief of VC Bac Chi District and Party Secretary of Trung Lap Village.

Truong Van Hai - Chief of Propaganda and Training Section and Information Service, Loc Hung Village.

(3) The Interrogation Prisoner of War Section, 25th MIC, processed 385 detainees during the quarter. This includes 199 VCG/VC/NVA PWs, 10 VCI PWs, 57 Returnees, 42 VCS CDs, 34 Civil Defendants, and 73 Innocent Civilians.

(a) For the quarter, the IPW Section developed 23 exploitable targets for field operational units. Exploiting these targets resulted in 21 VC KIA (BC), 20 PWs, 40 pounds of medical supplies, and two large ammunition caches.

CONFIDENTIAL

1. One of the above mentioned caches was found by 3rd Squadron, 4th Cavalry, while reacting to PW information in the vicinity of the Boi Loi Woods on 15 November 1969. Evacuated were: two 60mm mortars (complete), five ChiCom machine guns, five .30 caliber machine guns, one M60 machine gun, 17 K44 Carbines, six M3 submachine guns, three German Mausers, 15 extra machine gun barrels, and 42 cases of .31 caliber brass.

2. The second cache site was uncovered by 1st Battalion (Mechanized), 5th Infantry while reacting to Hoi Chanh information. Evacuated were: 31 122mm rockets (warhead assemblies and fuses) and 53 cases of .51 caliber ammunition.

(4) The G2 Air Section produced a moderate amount of area studies for brigade and battalion use. This represented a decrease in the amount from the previous three-month period. However, a number of requests have been received for area and trail studies of a new area of operation. Most of these studies will be accomplished in the next quarter. The Imagery Interpretation Section completed training of image interpreters at an in-country interpretation school in Saigon.

II Section Production - 1 Nov 69 to 31 Jan 70

	<u>NOV</u>	<u>DEC</u>	<u>JAN</u>	<u>TOTALS</u>
Readouts (Interpretation)	65	70	67	202
Mosaics	24	40	30	94
Area Studies	13	14	15	42
Road/Trail/Bridge Studies	6	4	0	10
Hand Held Annotations	0	12	11	23
Army Photo Missions	52	82	94	228
Air Force Photo Missions	12	9	5	26

(5) The Target Information Center (TIC) continued with success during the period. Its operation has helped identify enemy supply routes and enemy base areas. There was a study made of all the cache sites located during the past year which revealed that groups of caches were frequently located within a 500 meter diameter. These cluster centers were forwarded to the brigades to assist them in planning operations. So far the general locations have been along streams and known lines of communication used by the enemy. One large cache captured on 26 January resulted in the capture of: 200,000 rounds of small arms ammunition, 20 122mm rockets, 43 107mm rockets, seven 75mm recoilless rifle rounds, six 57mm recoilless rifle rounds, 25 RPG rounds, five 82mm

mortar rounds, 10 rifle grenades, 40 ChiCom hand grenades, 80 pounds of Chi-Com TNT. This cache was located very close to one of the cache study sites.

(6) Sensor devices continue to be successfully employed in the 25th Infantry Division TAOR, in both a target acquisition and intelligence role, through monitoring enemy locations, base areas, routes of infiltration, areas of mine and booby trap incidents and supply routes.

(a) The Duffel Bag program during this period significantly increased, with a total of 111 strings of 411 active sensors employed as compared to the previous reporting period of 76 strings of 232.

(b) During the reporting period, 2,159 enemy targets were acquired through Duffel Bag operations, 1512 of which were engaged with 31,506 rounds of artillery. Duffel Bag operations have been credited with the elimination of 299 enemy KIA (BC), 9 prisoners-of-war and numerous enemy weapons and equipment captured or destroyed. Significant Duffel Bag activities for the period were as follows:

1. On 5 November, Team 24, Company E, 75th Infantry (Ranger), while emplacing PSIDs around a night ambush position engaged and killed 1 NVA KIA (BC). While moving back to the ambush position they received activations from the PSIDs. Target was engaged with Light Fire Team, resulting in two additional NVA KIA (BC). This action indicates the usefulness of the PSID in providing early warning of enemy presence for patrol size elements.

2. On 6 November, a combat patrol vicinity XT6525 was reacting to a sensor activation and engaged an estimated 20 enemy, resulting in 14 NVA KIA (BC). Also, evacuated one AK-47 rifle, two RPG launchers, one K-54 pistol and $\frac{1}{2}$ pound of documents.

3. On 2 December, heavy sensor activations vicinity XT5131 were instrumental in troop operations resulting in nine NVA KIA (BC).

4. On 11 December, Company A, 2nd Battalion, 34th Armor, vicinity XT2959, located 16 enemy KIA (BC) killed by artillery initiated by Duffel Bag activations.

5. On 29 December, Company C, 2nd Battalion, 14th Infantry, during a ground sweep of a sensor field in the Cu Chi Rocket Belt vicinity XT6222, located 25 enemy KIA (BC) in 25 graves, killed by artillery initiated by Duffel Bag activations.

6. On 6 January, Company D, 2nd Battalion, 27th Infantry snipers vicinity XT3117 engaged an unknown number of enemy resulting in 17 enemy KIA (BC). Troop operations in the Angel's Wing sensor field were based primarily on heavy Duffel Bag activations in that area.

CONFIDENTIAL

7. On 24 January, Team 17, Company E, 75th Infantry (Ranger), vicinity X3544803, reacting to Duffel Bag activations, destroyed two tunnels, two bunkers, and four booby trapped (tripwired) hand grenades.

8. On 27 January, Team 17, Company E, 75th Infantry (Ranger), inserted vicinity X35179 because of heavy Duffel Bag activations, eliminated four enemy KIA (EC). Also, evacuated four homemade radios, 1/2 pound of documents and one AK-47 rifle.

(c) During the reporting period, the test and evaluation of the Battle Area Surveillance System (BASS) continued. Four phases of the five-phase test and evaluation plan has been completed with interim results proving its effectiveness in increasing the capabilities of the Duffel Bag program. BASS has provided the division with a centralized selective monitoring capability of remote sensors and permanent readout information for further analysis and future targeting. A data analysis section has been established as part of BASS to analyze and coordinate all Duffel Bag activity in the division. It is anticipated that the evaluation will be completed in 60 days.

(d) During the quarter, increased emphasis was placed on reaction to Duffel Bag activations other than by artillery. Bushmaster operations were instituted for use in areas of heavy activations and Ranger Team insertions have been providing significant results, as previously stated. Radar, in conjunction with sensor activations, continues to provide successful results in confirming and tracking enemy movement. More emphasis has recently been placed on non-immediate engagement, in order to develop true pattern studies for future targeting and operations.

d. (C) Operations:

(1) During the reporting period, the G3 Sections continued to develop plans and execute operations to preempt VC/NVA operations and to destroy VC/NVA forces.

(2) Doctrine, organization, and training were coordinated by G3 DOT. Reorganization of the Division's school system was accomplished, the mines and booby traps course was up-dated utilizing front line recommendations, Division regulations on training were published, and a day/night firing range was completed. Coordination with the 25th ARVN Division continued as assistance was provided to the 3rd Squadron, 10th Cavalry, the 25th ARVN Engineer Battalion, and individuals in many technical fields. Coordination was effected and finalized to train cadre at the Division's advanced combat marksmanship school. Training for US personnel continued to emphasize airmobile operations, small unit patrolling, ambush techniques, and marksmanship. DOT continued to coordinate evaluation of research and development projects. Thirty-four projects were in process during the period, and an additional fourteen evaluations will be initiated in the near future. Four evaluations, including that of the Night Hawk system, were completed. Significant projects

included XM191 Multi-shot Flame Weapon, Foliage Penetration Radar, Improved Position Locator, and Optimum Mix of Armored Vehicles. The reports and evaluation branch of DOT completed its reorganization and established its standard operation procedures. The current statistics section developed an offensive operations study which by comparing operations, enemy eliminated, and contacts gave each commander a graphic look at which operations produced results. All charts have been photographed and explained in a reference book, "25th Infantry Division Briefing Charts" which standardizes the charts and provides commanders and the staff a ready reference. The computer analysis section has continued to up-date and improve the computer programs. Computer printouts facilitated an easy and efficient yearly statistical summary. During the reporting period reorganizations were completed for the Nui Ba Den Provisional Company, the signal facility on Nui Ba Den, and the Tropic Lightning Academy, which is the division school system. Current projects include the reorganization of the 25th Infantry Division Augmentation Detachment Number One and the augmentation for the 341st Aviation Detachment (Division).

(3) The G3 Plans Section continued to coordinate all friendly operations conducted in the 25th Infantry Division TAOI. The sections coordinated areas of operations with the 5th ARVN Division, 25th ARVN Division, and adjacent US divisions. It also coordinated combined operations and provided planning guidance and mission assignments to maneuver units of the Division and the OPCOM 3rd Brigade, 9th Infantry Division. The maintenance of all G3 maps in the Tactical Operations Center and the preparation of all art work used in numerous briefings were accomplished by the section.

(4) The G3 Air Section coordinated the Division tactical air support and B-52 strikes. The USAF TACP assigned to support the Division was responsible for controlling tactical air strikes, visual reconnaissance, assistance in the development of B-52 targets, and B-52 bomb damage assessment. There were 2291 tactical air sorties flown in support of the division. The air strikes were in support of troops in contact, landing zone preparations, prestrikes, intelligence, and interdiction strikes. Bomb damage assessment was:

Killed by air (body count)	220
Killed by air (possible)	47
Bunkers destroyed	2579
Secondary fires	82
Secondary explosions	201

During this period there were three B-52 strikes in support of Division operations. Bomb damage assessment was:

Killed by air (body count)	2
Bunkers destroyed	70
Tunnels destroyed	7
Secondary explosions	22
Secondary fires	21

CONFIDENTIAL

(5) The Division Chemical Section and 9th Chemical Detachment continued to support division operations by employment of persistent and non-persistent riot control agents and by conduct of airborne personnel detector and defoliation missions. During the reporting period a total of 175 E-158 CS cannister clusters were dropped in flushing operations and in support of troops in contact. A total of 108,560 pounds of micropulverized CS powder was dropped from CH-47 aircraft to restrict known or suspected enemy infiltration routes, assembly areas and base camps. A total of 16,060 gallons of diesel fuel and 20,625 gallons of defoliant were sprayed around base camp, fire support bases and on approved defoliation projects in the division TAOI. During the reporting period airborne personnel detector missions accrued 481 hours of flying time, an increase of 311 hours over the previous reporting period. During this period, the Chemical Section and the 9th Chemical Detachment continued participation in combat evaluation of the XM191 Multi-shot Flame Weapon System. A total of 450 gallons of liquid for the Personnel Marking and Identification System was sprayed around the base of Nui Ba Den during the latter part of the reporting period, as the evaluation of the system continues.

(6) Army Aviation:

(a) During the reporting period the Army Aviation element was responsible for aviation support for the division and was under the direct staff supervision of the ACOFS, G3. During this period, Army combat aviation support was provided the 25th Infantry Division and the 3rd Brigade, 9th Infantry Division by organic and non-organic aviation units. Organic units which provided support included the 25th Aviation Battalion, Troop D, 3rd Squadron, 4th Cavalry, the 1st, 2nd, 3rd Brigades, 3rd Brigade, 9th Infantry Division, and DIVARTY aviation sections, and Company E, 725th Maintenance Battalion. Non-organic air support was furnished to the 25th Infantry Division by units of the 12th Combat Aviation Group. Assault helicopter companies and CH-47 aircraft were provided primarily by the 269th Combat Aviation Battalion whose units include the 116th Assault Helicopter Company, 187th Assault Helicopter Company, and the 242nd Assault Support Helicopter Company. Reconnaissance and surveillance was provided from the 73rd Surveillance Airplane Company (Mohawk) and the 74th and 187th Reconnaissance Airplane Companies (Bird Dog). Primary aero-medical evacuation was provided to the division by the 159th Medical Company. Additional non-organic air support was provided the 3rd Brigade, 9th Infantry Division from the 240th Assault Helicopter Company, the 222nd Combat Aviation Battalion, and 118th Assault Helicopter Company, 145th Combat Aviation Battalion.

(b) During the stated period the 12th Combat Aviation Group flew the following support for the Division and 3rd Brigade, 9th Infantry Division: 247,008 passengers airlifted, 124,925 sorties flown, and 19,983 tons of cargo airlifted.

(c) On 21 November 1969, the division requested and was granted by II FFORCEV authority to evaluate division level management of assault helicopter

CONFIDENTIAL

company assets. The evaluation was designed to determine if the division can utilize assault helicopter companies more efficiently with a monthly allocation of station time and flying hours rather than a daily station time and flying hours allocation. This test was conducted with the 116th and 187th Assault Helicopter Companies. The test was conducted from 21 November 1969 to 20 December 1969 from the 187th Assault Helicopter Company. The test provided flexibility in several areas. Day and night airmobile operations were conducted without sacrificing one for the other; station hours were split several times to achieve the desired results. Intelligence targets that were suitable for airmobile operations were immediately exploited. The flexibility enabled the rescheduling of maintenance and available operational hours with the minimum turbulence. Additional airmobile operations were conducted based on battlefield intelligence. The test also enabled the division to react to aircraft maintenance requirements through rescheduling of assets in accordance with both tactical and maintenance requirements at division level.

(d) On 15 December 1969, the 12th Combat Aviation Group began an evaluation to determine the capability and productivity of two assault helicopter companies and an air cavalry troop at full TO&E within the 25th Infantry Division area of operations. The evaluation is being conducted during the period 15 December 1969 to 15 March 1970.

(e) During the quarter, the 25th Aviation Battalion continued to support the division in Operation Toan Thang IV. Due to the requirements of mission support hours flown in support of the 25th Infantry Division during the reporting period, the following flying hour program by type and model of aircraft was established:

OH-6A	100 hours per aircraft per month
UH-1H	100 hours per aircraft per month
UH-1C	80 hours per aircraft per month
AH-1G	80 hours per aircraft per month

(f) There has been no change to daily aircraft requirements since the last reporting period. The battalion continues to support the 25th Infantry Division in a general support role.

(g) Statistical Summary of combat performance data: (1 Nov 69 - 31 Jan 70)

	<u>NOV</u>	<u>DEC</u>	<u>JAN</u>	<u>TOTAL</u>
Flight hours	3730	4273	3822	11825
Sorties	7623	7971	7309	22903
Passengers carried	7782	9503	9684	26969
Cargo carried (Tons)	384	344	301	1029
Enemy killed (Body count)	95	23	7	125
Enemy killed (Possible)	54	0	0	54

CONFIDENTIAL

	<u>NOV</u>	<u>DEC</u>	<u>JAN</u>	<u>TOTAL</u>
Enemy structures (Destroyed)	8	17	0	25
Enemy structures (Damaged)	0	0	0	0
Enemy sampans (Destroyed)	8	10	0	18
Enemy sampans (Damaged)	0	0	0	0
Aircraft hits	1	5	4	10

(h) There was no significant change in the operational concept of the division's air assets during the quarter.

(i) Statistical Summary of combat performance for Troop D, 3rd Squadron, 4th Cavalry: (1 Nov 69 - 31 Jan 70)

	<u>NOV</u>	<u>DEC</u>	<u>JAN</u>	<u>TOTAL</u>
Flight hours	2508	2370	2136	6914
Sorties	5196	5154	4668	15018
Passengers carried	4812	7091	7190	19093
Cargo carried (Tons)	16	14	5	35
Enemy killed (Body count)	43	10	9	62
Enemy killed (Possible)	0	0	0	0
Enemy structures (Destroyed)	14	12	8	34
Enemy structures (Damaged)	9	11	5	25
Enemy sampans (Destroyed)	44	0	6	50
Enemy sampans (Damaged)	2	1	4	7
Number of detainees	0	0	0	0
Number of prisoners-of-war	11	0	0	11

(j) During the reporting quarter the battalion experienced three major accidents. Causes are as follows: One UH1C crashed on a low level climbout; cause unknown. One AH1G received major damage when the aft attaching lug on the left inboard rocket launcher broke loose causing three (3) rockets to penetrate the aircraft fuselage. One UH1H crashed while making a night circling approach to a single strobe light. Troop D, 3-4 Cav (OPCON) experienced three major accidents also. One LOH crashed after a low level tree strike. Another LOH crashed after the pilot lost control of the aircraft. One AH1G crashed and was destroyed after experiencing material failure of anti-torque system (tail rotor).

(7) Engineer Operations:

(a) The Division Engineer Section, under the general staff supervision of the ACofS, G3 continued to coordinate Combat, Operational and MER Engineer Support to the 25th Infantry Division.

(b) During the period 1 November 1969 to 31 January 1969, the 65th Engineer Battalion, 25th Infantry Division, provided Combat Engineer Support to

CONFIDENTIAL

the division. In addition to the normal combat support, the 65th Engineer Battalion continued land clearing operations with the use of assigned dozers and anchor chains. Approximately 9,000 acres of hedgerows and light jungle were cleared during this period. In addition, the 65th Engineer Battalion emplaced a total of seven (7) fixed span bridges throughout the division area of operation to overcome trafficability problems incurred by the past rainy season. Two five (5) float-reinforced rafts were erected to provide platforms for a floating artillery section and pile driving rig. The 65th Engineers also participated in the II Field Force Secondary Road Program. The program is scheduled for completion in May 1970. The 65th Engineers have been assigned responsibility for 59.9 kilometers of road and to date have completed approximately 31 kilometers.

1. During this reporting period, Company A provided direct combat support to the 1st Brigade in Tay Ninh. Daily minesweeps of MSR's in the 1st Brigade area of operations coupled with combat engineer demolition teams in support of the 1st Brigade's battalions were an extremely important part of the combat engineer support provided.

a. The fire support bases in the brigade area of operations required continuous maintenance. This included providing fill for bunker construction, excavating trash sumps, build-up of berms, upgrade on interior roads and access roads, and providing technical assistance in construction of bunkers and defensive wires.

b. At FSB Washington, Company A provided 116 loads of fill for bunker construction and filling sandbags and dug four (4) trash sumps. Company A graded and ditched and placed 1200 gallons of penetrime on the interior roads and placed three (3) 36" half-culverts (culvert halves with timbers and old M8A1 matting covers) and leveled VIP parking lot in FSB Washington. The build-up of the perimeter berm was continued.

c. Company A maintained the access road and interior road of FSB Rawlins by spreading 52 loads of laterite and grading the entire road. Washed out sections of the perimeter berm were pushed up by a dozer and 28 loads of fill were provided to build up low areas of the berm. Company A also dug one (1) trash sump and provided three (3) loads of laterite and four (4) loads of sand for construction of a chapel at FSB Rawlins.

d. At FSB Buell Company A upgraded the access and interior roads with 235 loads of laterite, pushed up washed out sections of the perimeter berm. Company A also dug four (4) sumps at FSB Buell.

e. Company A used 132 loads of laterite to build up interior roads and 60 loads of fill for low areas at FSB Wood III prior to it being placed under control of the 2nd Brigade in December 1969.

f. FSB Stoneman and FSB Crook were closed by Company A during the past

60
CONFIDENTIAL

CONFIDENTIAL

quarter. Work included leveling the interior and the perimeter berm and filling sumps.

g. During the past quarter, Company A built a new FSB Hull and a new PB Lee. At FSB Hull 1097 loads of fill were used for low areas, berms and bunker revetments and 328 loads of laterite were used to build the interior roads. Company A also dug a well, supervised placement of a radar tower and supervised bunker construction and placement of defensive wire. At PB Lee, Company A pushed up a perimeter berm and provided 40 loads of fill for berms and bunker construction.

h. Company A was busy throughout the past quarter performing route maintenance on TL 13, LTL 26, QL 22, the unnamed road from Tay Ninh Base Camp to PB Lee, North West Bypass from Cao Xa to QL 22 and the Big Rubber Road.

i. On TL 13, Company A used 271 loads of laterite to fill large washed out sections of road between FSB Washington and FSB Crook. Company A graded from FSB Rawlins to the Big Rubber Road and spread 37 loads of laterite between Tay Ninh City and FSB Rawlins on LTL 26. On QL 22 North of Tay Ninh, Company A placed 88 loads of laterite in holes and ditched the same stretch of road. Company A spread and graded 29 loads of laterite on the Cao Xa Road between Cao Xa and QL 22. On the Big Rubber Road, Company A spread and graded 57 loads of rock and 1140 loads of laterite and spread 15,000 gallons of penepriime.

j. Company A performed many tasks at Tay Ninh Base Camp. Among these were 26 sumps and grease traps dug for FA&E, the use of 960 board feet of timber to brace the outer wall of the 1st Brigade TOC and the digging of 11 oil sumps at the power plant site. Company A used 159 loads of laterite to construct a flame bath pad and 104 loads of laterite to build up the perimeter berm on Tay Ninh Base Camp. A berm for a new ASP was pushed up and 35 loads of laterite were used to patch holes on the hover lanes at Tay Ninh.

k. At Mo Cong, Company A pushed up a berm for an artillery firebase site and at Tay Ninh East Company A used 440 board feet to reinforce the roof of the Combined Fire Support Coordination Center.

1. Company A penepriimed 300 meters of LTL 26 that passes through the hamlet of Ap Phuoc Hoa and graded secondary roads and the school yard in the same hamlet. At the Suoi Tra Fhat Bridge site, Company A used 72 loads of laterite to build up the east and west banks of the river for AVLB usage. Company A continued clearing fields of fire at the Nui Ba Den signal facility by expending 3896 pounds of explosives.

2. During this reporting period Company B was involved in a variety of tasks while furnishing general support to the 25th Infantry Division. Company B also provided direct support in the form of sweep and demolition teams

CONFIDENTIAL

to the 3rd Squadron, 4th Cavalry the entire quarter and to the 2nd Battalion, 34th Armor until 21 December when Company A began providing direct support to that unit.

a. In their role as direct support for the 3-4 Cav, Company B has been responsible for providing sweep teams necessary to their operations and for maintaining their fire support bases. While the 3-4 Cav was at FSB Hampton, Company B dug one well and built two personnel bunkers, sizes 12' x 16' x 8' and 15' x 20' x 8' using a total of 5000 board feet of lumber. One helipad was constructed out of compacted laterite and covered by membrane 52' x 36' in size and 123 55 gallon drums were placed into two sumps 15' in diameter and 20' deep and one 18" culvert 20' long was put in place. In addition, Company B used 133 loads of laterite, 20 loads of fill and 5 loads of gravel on the interior of FSB Hampton. Company B hauled 50 loads of unsuitable soil away from FSB Hampton and 1050 feet of berm was pushed in approximately 10 to 15 feet to decrease the size of FSB Hampton.

b. On or about 21 December 1969, Company B shifted its efforts from FSB Hampton to FSB Wood III to continue direct support to the 3-4 Cav. The first job started was the preparation of a new location for the artillery battery. This required 107 loads of laterite for filling low areas and leveling of 13,000 square feet with a dozer. Company B dug a well at FSB Wood III and placed six (6) loads of rock in the bottom and lined it with 35' of 48" culvert. A 75' x 300' area was cleared and covered with 25 loads of laterite and 60 barrels of peneprime. Company B also used 145 loads of laterite and 60 barrels of peneprime on the interior road at FSB Wood III.

c. Company B performed extensive work on upgrade of the Big Rubber Road, LTL 19, and LTL 26.

d. The Big Rubber Road project was a carry-over from the previous quarter. The project entailed keeping the road passable for convoys to Dau Tieng and for future use by local Vietnamese loggers. Company B spread 21 loads of laterite, 18 loads of rock and 216 bags of lime on the Big Rubber road.

e. LTL 19 was also a carry-over from the previous quarter. The road had at times been completely impassable to wheeled vehicles due to complete failure of the subgrade. A section of corduroy road 60 feet long was constructed using 3" x 16" x 9' timbers (1620 board feet) to enable the passing of Company B 5-ton dump trucks to the work area. In addition, two loads of scrap M8A1 matting, one load of rubber tree stumps and 57 loads of 6" minus rock were dumped into the bed sections. After the road was made passable to dump trucks, 616 loads of laterite and 324 bags of lime were hauled and spread on the surface of the road. Other sections of LTL 19 required major upgrading of the road surface. Materials used were 153 loads of laterite, 5 loads of rock and peneprime. Company B was able to manage with as little laterite as shown by pulling existing laterite from the road shoulders.

CONFIDENTIAL

CONFIDENTIAL

f. On LTL 26 Company B spread 354 loads of laterite and 3600 gallons of peneprims. Additional materials was also pulled from the shoulders of the road to fill in potholes.

g. Before the reorganization of the bunkerline, Company B was responsible for the upkeep of bunkers 57 thru 62 on Cu Chi Base Camp. The work done by Company B consisted of repairing the RPG screens in front of the bunkers, replacing 15 claymore wires, cutting and burning grass out to the 5th wire, installing 287 trip flares, and backblading, with a dozer, the area from the berm to the perimeter road. After the change of the bunkerline, Company B built a new bunker fighting position. Materials used on the bunker were: 24 cubic feet of concrete, 1546 board feet of timber and 150 ammo boxes for revetments. Company B also moved and reconstructed its lateral fighting positions and provided 30 loads of fill to build an 8' berm.

h. The RPG fence around Cu Chi was completed in November 1969. This project called for construction of 685 meters of 8' chain link fence. Company B also has the mission of building and installing 22 gates for the RPG fence around Cu Chi Base Camp. To date 88 hinges have been prefabricated for the gates and 27 pieces of 6" pipe 13' in length have been cut. Forty 15' and four 20' gate sections have been prefabricated and 23 of these 15' sections have been covered with chain linked fence. This project is still in progress.

i. Company B was involved in the construction of an ICC (Innocent Civilian Center) on Cu Chi Base Camp. Two SEA huts 16' x 32' were dismantled and all possible materials salvaged for use in construction of one 16' x 32' SEA hut, one shower, one four (4) seat latrine and two partitions in an existing building. A total of 2100 board feet of lumber was used for this project. Company B also moved a prefabricated water tower with tank for use at the shower.

j. Company B is constructing a Coordinated Fire Support Control Center at Bao Trai. This project has taken 18,000 board feet of timber, to date, and its overall dimensions are 42' x 66' x 13'. Ninety loads of sand were used to fill in an excavation so a floating 8" reinforced concrete pad could be poured. The water level was only three feet from the top of the ground where the bunker had to be constructed. Eighty cubic yards of concrete was used to pour the pad.

k. Company B also moved the battalion fuel point. Materials required were 10 loads of laterite, installation of 18" x 40' culvert and the use of 48 board feet of lumber to brace the tower.

l. One other project Company B was given was the rehabilitation of the battalion swimming pool. Work included reinforcing the sides and the use of 335 cubic feet of concrete on the edge of the pool to improve drainage during the wet season.

CONFIDENTIAL

3. During the entire reporting quarter, Company C continued to provide direct support to the 2nd Brigade. This combat support consisted of minesweep and demolition teams to the maneuver battalions of the 2nd Brigade.

a. Company C continued the upgrade and rehabilitation of the 2nd Brigade Fire support bases throughout the quarter.

b. At FSB Patton, Company C constructed one command bunker, one bunker on top of a radar tower, three .50 caliber machine gun positions, one senior NCO bunker and dug one sump 100' x 20' x 12'. Company C also improved the artillery and infantry mess halls by replacing culvert and screen doors. Other work on FSB Patton included construction of an additional engineer bunker and improvement of interior roads and drainage.

c. Company C constructed one mess hall sump and one grease trap on FSB Devin. Other work included construction of one bunker, construction of one berm 20' long, 4' high and a parking area 100' x 50' for a rifle range, and construction of a platform and machine gun mount on the observation tower.

d. At FSB Pershing, Company C constructed one mess hall sump, one grease trap, two ammo pits, rebuilt the berm and cleared area around the perimeter and constructed one garbage sump 100' long and 15' wide by 12' deep.

e. Company C did extensive upgrade of roads during the last reporting period. These roads were TL 7A North, TL 7 South of QL 1 and TL 6A North of QL 1.

f. On TL 7A North, Company C cleaned all culverts to improve drainage and burned grass on the roadside. Company C also improved road surface by upgrading and covering the road with 84 barrels of peneprims.

g. On TL 7A South, Company C installed four 12" POL pipes, three 40" culverts, 46 pieces of 3" x 12" x 12' corduroy, 6 loads of rock, 1940 loads of laterite, 2280 bags of lime and 229 barrels of peneprims to improve the road surface.

h. On TL 6A North, Company C installed one section of POL pipe and improved the road surface with 167 loads of laterite, 160 bags of lime and 186 barrels of peneprims.

i. Company C cleared 180 acres of land for a new ARVN Patrol Base on LTL 19 and on Cu Chi Base Camp constructed a new fighting bunker, 100 meters of berm 8' high and 2' wide at the top with 15 loads of fill on the bunker-line. Other work on Cu Chi Base Camp included building a grease rack for the motor pool.

j. Company C closed two patrol bases during the last reporting period. Those were PB Hunsley and PB Dees. Work included leveling berm and burying wire.

CONFIDENTIAL

4. During this reporting period, Company D continued to provide direct support to the 3rd Brigade with minesweep and demolition teams.

a. Company D performed continuous work on the fire support bases in the 3rd Brigade area of operations. At FSB Chamberlain, Company D hauled 146 loads of fill to heighten and upgrade the berm. This work was coupled with the perpetual task of maintaining the access and interior roads at the base. Penepime was used for dust control on the two forementioned roads. A well was also dug at FSB Chamberlain by Company D. In addition, Company D dug a well at FSB Jackson during the past quarter. Other work done on FSB Jackson included general upgrade work on the interior of the fire support base. Penepime was distributed on the helipad for dust control and 159 acres of scrub brush was cleared around FSB Jackson to improve fields of fire.

b. Company D installed an aluminum foot bridge across a canal at PB Handle. This bridge was 100 feet long.

c. Company D's major construction project last quarter was the construction of a new FSB Dixon. A total of 3311 loads of laterite and 118 loads of fill were used in the base to build up low areas and make an interior road net. Two wells were dug at FSB Dixon and a 20' observation tower was lifted in to accomodate the radar equipment.

d. Company D also constructed and placed two 20' towers at PB Kotrc and a squad repaired the timber decking on the Phuoc Luu Bridge.

e. The repair and upgrading of the roads in the 3rd Brigade area of operations was a continuous chore. As the seasonal rains subsided, road maintenance became easier and work progressed at a more rapid rate. Concentrated engineer effort was employed at several locations to upgrade important convoy routes.

f. As the rains stopped, Company D moved north of TL 10 on 7A and began its upgrade from TL 10 to the 3rd Brigade boundary. This upgrade required 346 loads of laterite and 900 bags of lime to fill holes caused by tracked vehicles during the wet season.

g. The clearing and upgrading of Route 1000 was also accomplished by Company D during the last reporting period. Company D hauled 278 loads of rock from Long Binh to repair the deeper holes and flooded areas. The rock base and other areas were then capped with 2151 loads of laterite and coated with penepime. Approximately 250 acres of vegetation were cleared along this road.

h. On Cu Chi Base Camp, Company D has provided direct support to the 3rd Brigade. Extensive upgrading has been completed on Snoopy helipad. Company D hauled 146 loads of laterite to level the area which was then graded,

CONFIDENTIAL

rolled and coated with penepriime. Company D also relocated 300 feet of revetments for the 3rd Squadron, 4th Cavalry's helicopters on Cu Chi. Company D also assisted 3rd Brigade in the erection of revetments for Snoopy Pad.

5. During this reporting period, Company E provided general support to the 25th Infantry Division in the form of bridging, construction and land clearing.

a. The following bridge missions have been successfully completed by Company E in the past reporting period.

b. Company E performed maintenance on the two Bailey Bridges within the Division's TAO. All bolts were checked, sway braces tightened and both bridges were spot painted as necessary.

c. Seven 45 foot M4T6 dry span bridges were constructed in Cu Chi and airlifted by a CH-54 helicopter to the lower Boi Loi Woods by Company E. The bridges were used to pass traffic on soft spots from TL 6A into the Boi Loi Woods. This mission was in support of 3-4 Cav operations in the area during the latter part of the rainy season.

d. After passing the 3-4 Cav traffic for two weeks, the road deteriorated to the point that it was impassable to vehicular traffic. The bridges were then airlifted from their initial location to a new site one kilometer to the northeast. Here the dry spans were laid end to end to make a continuous roadway 315 feet long over a soft area.

e. After another month the roadway was reinforced with additional bulk to accomodate M48A tanks. Two weeks later the bridges were extracted using CH-54s to lift the frames and CH-47s to carry the extra bulk.

f. A five float reinforced M4T6 raft was constructed in support of the 1st Battalion, 27th Infantry. This raft, nicknamed "Buttercup", was constructed at the Sugar Mill. It was used as a mobile platform on which a tracked twin 40mm cannon (Duster) was mounted. The raft was used for a month on the Vam Co Dong River and during this time, Company E performed maintenance on it. At the end of a month's operation, the raft and mounted "Duster" was no longer deemed tactically necessary and was disassembled. While installing the raft, a wooden bridge leading into the Sugar Mill was damaged by the weight of the vehicles connected with the operation and to correct the damage, a 15 foot dry span was emplaced to bridge the gap.

g. Company E, in their general support role, constructed a new command bunker, tower and ammo bunker for Golf Sector of the Cu Chi bunkerline. The complex included a new command bunker with a 30 foot tower. Next to the complex was built a central ammo supply point. A total of 21,014 board feet of timber were used to construct this complex.

CONFIDENTIAL

h. When the Golf Sector of the Cu Chi bunkerline was moved, Company E built two new fighting bunkers, and six alternate fighting positions. Company E also provided 50 dump truck loads of laterite on the berm to bring it to a 8' height. Company E also constructed 400 meters of 6-3 double apron fence along their section of the bunkerline. Other work on the bunkerline included the installation of 68 Claymore mines.

i. On LTL 19, Company E installed two 18" culverts 36 feet long. Other culvert construction included the construction of five 36" and four 30" culverts 40 feet long for use in the drainage system of the S-4 back yard. Company E also constructed three fences of three strand barbed wire around the penprime yard, rock pile and gravel pile on Cu Chi Base Camp.

j. During this reporting period, Company E hauled 23 bridge truck loads of laterite to Hiep Hoa to upgrade the main road. A labor force of villagers and Company E personnel off-loaded the trucks by hand. Upon completion of this project, 32 more truck loads were hauled to Trang Bang soccer field. Again a labor force of civilians and Company E personnel off-loaded the trucks by hand.

k. Company E was involved in the land clearing program throughout the entire reporting period. A total of 7,390 acres were cleared in the following areas:

Southeast of Cu Chi (XT6911)	1060 acres
Southern Filhol (XT6817)	345 acres
North of Cu Chi (XT6215)	275 acres
Southwestern Filhol (XT6319)	750 acres
Northeast of FSB Hampton (XT4425)	505 acres
Along Route 239 (XT4545)	710 acres
Western Filhol (XT6221)	1350 acres
Along TL 7A (XT5315)	810 acres
North of Bao Trai (XT5310)	1285 acres
Northwest of Trung Lap (XT5723)	300 acres

l. The 65th Engineer method of clearing land is the use of two dozers with a heavy anchor chain pulled between them. This method enables more cut acreage in a day's time. It is only effective for areas previously cut by Rome Plows, or acres with only small scrub or bamboo hedgerows

(c) The 588th Engineer Battalion (Combat) with the 362nd Engineer Company (Light Equipment) attached, located at Tay Ninh, provided engineer support in the northern part of the Division TAOI. Companies A and C, 588th Engineer Battalion, located at Cu Chi, have continued to provide Operational Support, MER Support, LOC repair and recently began work on the II Field Force Secondary Road Program. Some significant projects of the 588th Engineer Battalion included earthen berm construction, aircraft maintenance Ramps, Cu Chi Fire Station, cluster positions, maintenance of defensive works

CONFIDENTIAL

at Cu Chi, rehabilitation of Tay Ninh Airfield, helicopter refuel point upgrade, Minimum Essential Requirement at Tay Ninh and FSB Chamberlain, and the construction of the barge site at Ap Phu Ninh. The 588th Engineers contribution to the II Field Force Secondary Road Program included responsibility for 48.5 kilometers of road of which approximately one kilometer has been completed.

(d) The 168th Engineer Battalion, with the 595th Engineer Company (Light Equipment) attached, provided three companies for the current Secondary Road Program. Company A, operating from Dau Tieng, and Company D and the 595th Engineer Company from Cu Chi, have been assigned the responsibility for 90.9 kilometers of road in Tay Ninh and Hau Nghia Provinces and to date have completed 18.5 kilometers.

(e) The 3rd Brigade, 9th Infantry Division, which is under the operational control of the 25th Infantry Division, continued to be supported by the 571st Engineer Company (Combat), formerly Company C, 15th Engineer Battalion, in direct support and the 93rd Engineer Battalion (Construction), a subordinate unit of the 20th Engineer Brigade, providing Engineer Operational Support.

(f) In the II Field Force Secondary Road Program, the 571st Engineer Company has been assigned responsibility for 26.3 kilometers of road and to date has completed 6.5 kilometers. The 93rd Engineer Battalion has committed one company to the II Field Force Secondary Road Program in Long An Province. The 93rd Engineers have been assigned responsibility for 71.6 kilometers of road and to date have completed 3.5 kilometers.

(g) The Fire Support Element worked under the general staff supervision of the ACofS, G3. The Division Artillery Command supervised the FSE as Division Fire Support Coordinator. The FSE continued to coordinate the fire support for the maneuver elements of the division and supervised the artillery warning control centers. Each maneuver brigade was provided direct support by a light artillery battalion. Although there were attachments and detachments, normally support was provided as follows:

1st Brigade	7th Battalion, 11th Artillery
2nd Brigade	1st Battalion, 8th Artillery
3rd Brigade	2nd Battalion, 77th Artillery

The 3rd Battalion, 13th Artillery (155/8") provided general support for the division.

(9) Signal Operations:

(a) The Division Signal Office continued its coordination and staff supervision over all communications within the division.

CONFIDENTIAL

(b) During the quarter ending 31 January significant changes in communications administration were effected. This was done while providing continuing combat signal support to the 25th Infantry Division.

(c) In order to bring the Division SOI and SSI up-to-date and in accordance with Army doctrine, the Division SOI was completely rewritten. The Division SOI was changed in format to make it easier to use and to bring it into agreement with the SSI. Division regulations relative to Communications-Electronics matters were also reviewed and updated for the year.

(d) A detailed and comprehensive survey of all communications-electronics components and systems was completed in October. This report was prepared for USARV in support of a congressional subcommittee looking into communications support for the Army in the field.

(e) The 160 foot communications tower and communications bunker scheduled for completion at the Go Dau Ha MACV Compound in December 1969 is not now expected to be completed until March 1970. Construction delays and questions over property rights have caused the delay. The proposed relay site will be installed when the site becomes operational.

(f) In his continuing effort to provide the men of the 25th Infantry Division with the best possible MARS service, the Division MARS Director developed a program of providing MARS telephone patch service directly to the fire support bases by utilizing the Division VHF radio systems. This not only resulted in an increase in the number of calls completed but saved many man-hours and equipment-hours. During the period 1 November to 31 January 4,032 calls were made over the MARS system.

(g) Detailed planning for Operation Holly - the Bob Hope Christmas Show began in early December. This detailed planning included not only the reengineering of the sound system for the Lightning Bowl, but the development of a plan to provide the sound from the show to the hospital and to all the fire support bases in the Division. Because of this sound prior planning the show was flawlessly supported and not a minute of the show was missed at the hospital or fire support bases.

(h) Planning began in mid-January for the opening of a communications facility at Dau Tieng in support of the 2nd Brigade, 25th Infantry Division and its OPCON battalions. The facility is programmed to handle a relay, four VHF terminals, a patch panel and a systems control facility. The facility is expected to be fully operational on 15 February.

(i) During the month of January four members of the Division Signal Office staff were regularly involved in conducting the Communications-Electronics and Cryptographic portions of the Division Pre-AGI.

e. (C) Logistics:

CONFIDENTIAL

(1) A total of 1,287 major items of equipment were issued by the Division Supply Office during the reporting period. Monthly totals were as follows:

<u>Month</u>	<u>Line Items</u>	<u>Total Items</u>
Nov	62	585
Dec	53	211
Jan	<u>34</u>	<u>491</u>
TOTAL	149	1287

(2) A program was initiated in November to issue M16 rifles to replacements upon arrival at the Replacement Training Center. Tay Ninh based units required augmentation rifle issues to establish a floating inventory in excess of authorization to account for time required to inspect and transport rifles from Tay Ninh to Cu Chi.

(3) Receipt of 32 5 Ton Cargo Trucks during the month of January brought the Division up to its full MTOE authorization of 90. A critical shortage of this item had existed throughout 1969.

(4) In December the Division Support Command was notified by letter of those major items of equipment which are to be controlled by this headquarters. New lateral transfer procedures were instituted to insure proper demand cancellation and submission when in-coming equipment is to be diverted from the intended unit of receipt to another. Continuation of this procedure is expected to purge the system of invalid demands and permit proper depot to unit reconciliation.

(5) In an effort to conserve contractual Laundry funds, Saigon Support Command directed that flat work (bed sheets, pillow cases, and mattress covers) would not be submitted to contractual laundry facilities for processing. These items are to be diverted to 1st Logistical Command Quarter-master Laundry facilities which have not been operating at an acceptable volume. To conform with the directive but to avoid a discontinuity in service, unit residents at the Cu Chi Base Camp have been phased by three battalion blocks from the Contract Laundry to the 1st Logistical Command facility. To date approximately one half of the Cu Chi Base Camp supportable strength is submitting flat work to the 1st Logistical Command for processing.

(6) In January 1970, a major effort was undertaken to establish proper accountability for equipment in excess to authorization. This was accomplished through a simplified procedure of picking up equipment on property books and establishing the excess as a temporary loan as authorized by USARV. Based on the reports submitted, it appears that most units did conduct thorough inventories and reported all excess equipment on which retention was desired.

CONFIDENTIAL

(7) A monthly average of eleven different conventional Class V items were subject to ASR control. At the beginning of the reporting period, HE illumination munitions were the principal items under management; however, mid-way through the reporting period there was a transformation from illumination to HE munitions which continued to be the predominant munition under management. During the reporting period, three HE and one illumination type munitions required supplemental allocations in order to support tactical operations.

(8) The availability of construction materials was critical throughout the period. The construction of FSB Dixon was delayed because of the lack of bunker timbers. Availability of concertina wire fluctuated while demands remained constantly high. USARV issued policy guidance indicating that chain link fencing would not be authorized to encircle the perimeters of base camps, fire support bases, or patrol bases. Base camp construction requirements were continuously reviewed to purge unnecessary construction. The program to isolate unauthorized construction at base camps continued.

(9) The PHILCAGV moved out of the Tay Ninh Base Camp during the period. At present the 1st Brigade, 1st Air Cavalry Division occupies the old PHILCAGV area in the base camp with only a small stay-behind PHILCAGV force remaining.

(10) Because of an increased incidence of malaria within the 25th Infantry Division area of operations during the latter part of 1968, all Division personnel were instructed to take the Dapsone antimalarial as of 19 December 1968, as well as the C-P pill. This policy was authorized until 2 October 1969, when, because of low rates of malaria in the 2nd Brigade and 3rd Brigade areas of operations, these areas were exempted from taking the Dapsone pill. The 1st Brigade area continued on Dapsone until 27 December 1969, when they were also no longer required to take Dapsone. The decisions were based on USARV recommendations of the use of Dapsone in areas with rates greater than 20 cases/1000 men per year.

(11) Between 4 January 1970 and 11 January 1970, an average overnight strength of 400 men of Companies A, B, C, D of the 3rd Battalion, 22nd Infantry were engaged in operations on the slopes of Nui Ba Den (Black Virgin) Mountain). From 14 January to 27 January, there were 10 cases of Falciparum and 2 cases of Vivax malaria diagnosed in men who were engaged in the operations on the mountain. This is a Falciparum malaria rate of 10 cases/400 men/week or 1300 cases/1000 men/year.

(12) The Division Support Command provided combat service support to divisional units, non-divisional units, and certain U.S. Navy elements participating in Phases III and IV of Operation TOAN THANG. Support was provided from logistical facilities located at Cu Chi Base Camp, Tay Ninh Base Camp, and the Duc Hoa refuel/rearm point.

CONFIDENTIAL

Because combat service support in the Division's area of operations (AO) is done on an area basis, the 1st Brigade received Class I, some Class II and Class III from the 277th Supply & Service Battalion at Tay Ninh Base Camp. Support not otherwise available to divisional units located in the Tay Ninh area was provided by DISCOM. All units, divisional and lodger, located in the Cu Chi Base Camp area were provided Class I, some Class II, Class III, and Class IV support by DISCOM. All Class V support for all units in the 25th Infantry Division AO was provided from 3rd Ordnance Battalion ASP located at Cu Chi and Tay Ninh Base Camps, or by means of direct through-put delivery from the 3rd Ordnance Battalion Depot at Long Binh.

(a) Operation Holly, which occurred on 23 December 1969, was supported through supply, construction and transportation actions. Representatives from all units in the division came to Cu Chi Base Camp to witness the Bob Hope Show. Over 3400 men were moved in and out of Cu Chi Base Camp by truck, CH-47 helicopter and U.S. Air Force aircraft in a twelve (12) hour period. During this operation, it was determined that the Cu Chi Base Camp airstrip could accommodate the arrival and departure of up to twelve C-130 and C-7A aircraft per hour if necessary; the previous maximum number was thought to be only four per hour.

(b) In December 1969, the command structure of DISCOM Forward at Tay Ninh was disestablished to realign forward combat service support coordination with the latest doctrine outlined in FM 54-2 (The Division Support Command). This clarified the chain of command between CO, DISCOM, direct support battalion commanders, and their forward elements. DISCOM Forward was replaced by the DISCOM Liaison Officer. Personnel saved were used to augment the office of the Installation Coordinator at Tay Ninh.

(c) Operational control of the Division CMMI Team and the allocation authority for command controlled lumber assets were transferred from DISCOM to Divisional control (G-4).

(d) Following are significant projects accomplished by the office of the Installation Coordinator, Cu Chi Base Camp (CO, DISCOM).

1. Cu Chi Base Camp Memorandum was published setting forth guidelines for physical security of critical facilities, sensitive facilities and unit areas.

2. Major construction projects completed included base camp perimeter lighting, two (2) aircraft maintenance shop ramps, the base camp fire station, the Innocent Civilian Center, and a separate gate for PA&E local workers.

(e) DISCOM elements participated in 68 Medical Civic Action/Intelligence Civic Action Programs (MEDCAP/I-CAP) during this period. Of 9,118 patients treated, 825 were dental. In addition, dental hygiene and fluoridation classes were conducted. Twenty-four civic action construction and relief projects

CONFIDENTIAL

were completed at a cost of 206,500 \$VN. The largest was a Buddhist School at Vinh Cu. This project was financed with donations from the 725th Maintenance Battalion. Labor was provided entirely by the village inhabitants. The Cu Chi District Chief, Captain Dinh, and Brigadier General Greene, ADC, 25th Infantry Division, participated in dedication ceremonies when the school was completed.

(f) By careful management, the Division Transportation Officer was able to improve the utilization of cargo aviation assets made available to the division. By central scheduling and close coordination with supported maneuver units, combat essential hours were held to seven during November and December. Increased enemy activity during January required thirteen combat essential hours. Average tons per CH-47/54 blade hour was increased from an average of 7.3 experienced during the last quarter to an all-time high of 9.5. CH-47/54 utilization, the difference between allotted hours and actual hours flown, rose to 98%. The tons-of-cargo and number-of-troops moved by USAF fixed wing cargo aircraft increased by 1% and 8%, respectively. A total of 670 tons and 43,000 troops were moved by this means. In addition, 756 motor convoys, totaling more than 15,500 vehicles of all types moved through the division AO without a major incident.

(g) Utilization of the Division Band increased throughout the division TAOI. In addition to normal commitments, the band supported MEDCAPS, to include one conducted at night. The presence of the band stimulated greater participation on the part of the population. Also during this period the Division Bandmaster composed a new march, The Fighting 25th. The march has become the official 25th Division March and is played during appropriate division ceremonies.

(13) 25th Medical Battalion.

(a) The 25th Medical Battalion supported division units with medical service and supplies and certain non-divisional units with medical supplies. Supply and service activity statistics follow:

- (1) Medical:
 - Patients seen: 12,916
 - Diagnosed diseases: 11,332
 - Diagnosed non-battle injuries: 1,242
 - Diagnosed IRHA: 342
- (2) Supply and services:
 - Line items issued: 3,832
 - MEDCAP line items issued: 2,370
 - Bulk pharmacy items issued: 5

(b) The 40th Medical Detachment (KJ) provided dental treatment as follows:

CONFIDENTIAL

(1) Total treatments: 16,930

(2) Civic Actions: 2,660 patients

(c) The 159th Medical Detachment (HA) evacuation and aircraft statistics are as follows:

(1) Total patients moved: 2,249

(2) Total missions flown: 1,294

(3) Flying time: 1,290 hours

(4) Average aircraft availability percentage: 88.45%

(5) Average aircraft flyable percentage: 66.66%

(14) 25th Supply and Transportation Battalion:

(a) Two 1800 cubic foot reefers were installed in the Class I yard by PA&E during the reporting period replacing two 1600 foot reefers. This increased storage capacity enabled the consolidation of all PX and Snack Bar items into one reefer.

(b) The Class II and IV yard was reorganized to improve control and facilitate locating and issue of stored items. A project to rewarehouse all stock was 90% completed.

(c) A new entrance to the retail MOCAS and DP-2 (diesel) outlets was established to reduce the traffic congestion.

(d) During the reporting period, Company B hauled 14,941 tons of cargo in support of the 25th Infantry Division. In addition the company delivered 6,845,500 gallons of water to units stationed at Cu Chi Base Camp and transported 34,270 troops.

(e) A total of 3,935 air delivery sorties were flown in the Division during the reporting period with no malfunctions. The month of December marked the seventh consecutive month without any malfunctions. This is attributable to an increased emphasis on proper helicopter external lift procedures and extensive inspection and training programs.

(f) The NCR 500 computer system was received during the latter part of November. This system was placed on concrete pads in the Class II and IV yard and surrounded by protective revetments. Actions were started to

CONFIDENTIAL

automate supply, accounting and requisition procedures early in February 1970.

(15) 341st Aviation Detachment (Divisional).

(a) The 341st Aviation Detachment (Div) has operational control of the Cu Chi Army Airfield. There were 161,435 aircraft movements on the Cu Chi Installation for the reporting period and 1,420 ground control approaches.

(b) The 341st Aviation Detachment (Div) has operational control of the 25th Infantry Division rearmament facility for helicopter gunships and issued the following amounts of ammunition during the last three months:

Army Rockets: 37,304
Air Force Rockets: 7,258
7.62mm Rounds: 2,937,000
40mm Rounds: 31,300
Smoke Grenades: 1,928
Aircraft Flares: 3,252

(c) The 341st Aviation Detachment (Div) also has operational control of the aircraft POL facility. The following amounts of fuel were dispensed during the last quarter:

AvGas: 27,655 gallons
JP-4: 2,424,000 gallons

f. (C) Communications:

(1) During the reporting period, the 125th Signal Battalion provided the division the following communications facilities:

(a) FM Radio. The battalion provided the personnel and equipment for the division stations in the following nets:

- 1 Division Command Secure Net.
- 2 Division Intelligence Net.
- 3 IIFV Command Net.
- 4 Automatic retransmission facilities at Nui Ba Den for Divisional Command Secure Net.
- 5 RWI Station on Cu Chi Base Camp.
- 6 125th Signal Battalion Command Net.

CONFIDENTIAL

(b) AM RATT: The Battalion provides equipment and personnel for the Division Command RATT Net.

(c) Communications Center: The 25th Infantry Division Communications Center facilities are provided by the 125th Signal Battalion. During the reporting period, an average of 1,800 messages were handled per month. Of the traffic handled 60% was originating traffic, 40% terminating traffic, and 10% was hand carried messages. High precedence traffic continued to be passed at high volume. An average of 65% of all traffic handled had precedence of immediate or higher. Additionally, communications center facilities are provided at Tay Ninh Base Camp.

(d) Telephone Switching Centers: An AN/MTC-1 with 5 dial trunks is used for the Division Main Switchboard. This switchboard is being used in lieu of the authorized AN/MTC-3 because of the number of non-divisional units and subordinate divisional unit's rear areas requiring drops or access to Lightning Main Switch.

(2) Significant Events:

(a) The FM antennas located at DTCC were re-engineered and adjusted to reassigned frequencies for better reception.

(b) During the reporting period the battalion has installed MARS radio support to all fire support bases in the division, using the multi-channel VHF systems.

(c) During the holiday season music was transmitted to all the outlying FSB's using the multichannel VHF systems.

(d) The audio portion of the Bob Hope and New Christy Minstrels USO shows, which were held in Cu Chi, were transmitted to all the outlying FSBs and to 12th Evacuation Hospital wards.

(e) The 125th Signal Battalion participation in the Cu Chi Telephone Management Agency was discontinued on 12 January 1970 and all personnel and equipment returned to the 125th Signal Battalion.

(f) The secure radioteletype net between DISCOM and DISCOM forward at Tay Ninh was discontinued on 25 January 1970.

(g) On 28 January the teletypewriter equipment in the DTCC was re-located to the Division Communications Center.

(h) Brigadier General Greene, the Assistant Division Commander, visited the battalion on 10 January 1970. He received a battalion briefing and was taken on a tour of the battalion's operational facilities on Cu Chi Base Camp. The 125th Signal Battalion was placed under BG Greene's super-

CONFIDENTIAL

vision on 10 January 1970.

(i) During the reporting period the Division Photo Lab processed 641 work orders producing 19,929 prints and 57 slides.

(j) The four Division MARS stations processed the following traffic between 1 December and 31 January:

- 1 Total number of requests: 7994
- 2 Total number of requests passed: 4769
- 3 Total number of calls completed: 3222
- 4 Records of calls were not maintained prior to 1 December 1969.

(k) The multichannel systems were changed as follows:

1 The systems of FSB St Barbara were discontinued on 1 Nov 69 and AN/MRC-69 was returned to B Company, 125th Signal Battalion at Tay Ninh.

2 The systems to FSB Stoneman was discontinued on 4 Nov 69 and the AN/MRC-69 was returned to 125th Signal Battalion, Cu Chi.

3 On 4 Nov 69 FSB Hull was opened, and a four channel system using the AN/GRC-163 was put into use between FSB Hull and Tay Ninh.

4 On 25 Nov 69 the multichannel systems between Cu Chi and Tan An was upgraded by the installation of a relay at Duc Hoa. This system greatly improved the quality of communications.

5 On 13 Dec 69 the system from FSB Wood was reterminated in Cu Chi instead of Tay Ninh. The quality of the system was considerably improved.

6 On 13 Dec 69 AN/MRC-69 equipment in use at FSB Hampton was replaced with a four channel system using an AN/GRC-163.

7 The system to FSB Crook was discontinued on 30 Dec 69, and AN/MRC-69 equipment and personnel was returned to Tay Ninh.

8 The system to FSB Patton was discontinued on 25 Jan 70 and the AN/MRC-69 equipment was returned to Cu Chi.

9 On 28 Jan 70 equipment for the AN/MRC-69 located at FSB Devin was relocated within the FSB due to build up of the area.

g. (C) Material:

CONFIDENTIAL

(1) The 725th Maintenance Battalion continued to provide direct support maintenance and class IX supply support for units assigned to the division. During the month of December, the battalion recorded a new low average back-log of 149 pieces of equipment in support maintenance (DS/GS), and on 29 December the back-log was reduced to 123 items; this was the low point both for December and 1969.

(2) Percentage of aircraft operationally ready during the reporting period was 87.7% compared to the previous reporting period of 86%. The high aircraft turnover in maintenance, along with planned scheduling of inspection, precluded an anticipated maintenance back-log which would have occurred with the newly issued OH-6 aircraft reaching the initial 300 hour inspection at the same time.

(3) The 725th Maintenance Battalion was issued a second NCA 500 computer system in late September. This permitted the automation of aircraft maintenance supply operation in E Company. Previously E Company shared the NCR 500 operation with Headquarters and A Company. The increased number of program runs per week made possible by the second NCR 500 significantly improved Class IX service in Headquarters and A Company and E Company.

(4) During the month of December, the 725th Maintenance Battalion provided a Technical Maintenance and Supply Contact Team to assist the organic facilities of 3rd Brigade, 9th Infantry Division. This assistance resulted in expediting the retrograde of all unserviceable, repairable equipment, a 50% reduction in the back-log, and evacuation of excess repair parts (Class IX).

(5) Headquarters and A Company, 725th Maintenance Battalion Technical Supply had a 53% demand satisfaction average for November and December of 1969. Unless there is a decrease in the number of lines at zero balance, demand satisfaction is expected to retain its present level. The command-wide demand satisfaction average for supporting DSU/GSU's is 52%. Demand accommodation for the same period was 89%, which was 10% above the 1st Log average and 4% above their goal of 85%.

(6) During the month of November, the 725th Maintenance Battalion performed a quarterly borescope/pullover gauge inspection on all artillery tubes, tanks, and mortars; the project was Division-wide and will be continued on a quarterly basis.

h. Revolutionary Development/Pacification.

(1) Within the TAOI, the Village Self-Development program is continuing to gain momentum. Nearly all of the villages with elected officials made use of their self-development funds and the objective of the program, namely involving the people in the villages in their own improvement, is being attained. The 2nd Civil Affairs Company is departing the

CONFIDENTIAL

TAOI and its role of coordination will be assumed by the Deputy District Senior Advisors in each province. During the reporting period, due to the upwelling in self-development programs, civic action support provided by the 25th Infantry Division units again dropped by nearly 50% over the previous quarter.

(2) The MACV Hamlet Evaluation System Ratings for the end of the reporting period show the following:

<u>Province</u>	<u>A</u>	<u>B</u>	<u>C</u>	<u>D</u>	<u>E</u>	<u>VC</u>	<u>TOTAL</u>
Tay Ninh	1	91	27	-	-	-	119
Hau Nghia	0	35*	84*	16	-	-	135
Long An	1	100*	165*	91*	10*	17*	384

*estimate 31 Jan 70

(3) Also at the end of the reporting period, the HES report carries the following percent of population living in pacified hamlets (HES category "C" or higher):

Tay Ninh	99.7%
Hau Nghia	91.3%
Long An	78.3%

1. (C) Civic Action.

(1) MEDCAPS have continued during the reporting period with 2893 MEDCAPS conducted treating 97,480 patients. This represents an increase over the previous quarter in which there were 1100 MEDCAPS treating 82,500 patients. In this area, emphasis is also being placed on the GVN participation in combined MEDCAPS when possible.

(2) The RF/PF Medic training program continues with 15 medics attending courses at the 12th Evacuation Hospital during the reporting period. (The course as conducted is of six weeks duration with classroom work in the morning and participation in the conduct of MEDCAPS in the afternoon.)

(3) Civic Action Imprest Fund expenditures during the quarter totaled 567,815 \$VN. Due to a reduction in funding levels for CY 70, the imprest fund was cut from 500,000 \$VN per month in November and December, to 150,000 \$VN in January. This downward trend in available funds will continue and the level will be 50,000 \$VN per month in the second calendar quarter of 1970. The level will drop to 25,000 \$VN for the third and fourth calendar quarters of 1970.

CONFIDENTIAL

j. (U) Psychological Operations (PSYOP).

(1) PSYOP activities were in support of operations conducted in Tay Ninh, Hau Nghia and Long An Provinces.

(2) A total of 54,480,000 leaflets were disseminated in the Division TAOI. This is an increase of 24,240,000 leaflets over the last reporting period. Approximately 180 leaflets were developed by the 25th Infantry Division and approximately 60 of these were printed by the ACoS, G5. The remaining 120 leaflets were forwarded to 6th PSYOP for reproduction.

(3) During the reporting period, 4323 hours of air and ground loudspeaker broadcasts were conducted. This represents a 3098 hour increase over the last reporting period.

(4) During this reporting period a total of 1180 Hoi Chanh rallied to the GVN in the 25th Infantry Division's TAOI, which is a decrease of 713 from the last reporting period.

(5) The 25th Infantry Division actively participated in the TINH THUONG Campaign during the reporting period. This campaign was primarily aimed at NVA troops in Binh Duong and Tay Ninh Provinces in an attempt to increase the Hoi Chanh rate. Preplanned targets were forwarded to CEPOC and the 25th Infantry Division itself developed and disseminated over 4,000,000 leaflets in support of this campaign.

(6) A new PSYOP technique developed during the reporting period. "Chieu Hoi - Tet Rice Bags" which consist of a plastic bag filled with a cupful of rice and five appropriate leaflets were distributed to field units who left the bags in conspicuous places in enemy territory. At present, it is too early to ascertain the success of this technique.

2. (C) Lessons Learned: Commander's Observations, Evaluations and Recommendations.

a. (U) Personnel. None.

b. (C) Intelligence.

(1) Pin-pointing the exact locations of targeted areas.

(a) Observation: Pin-pointing the exact locations of the targeted areas has been largely successful by having the sources draw simple sketches of the area.

(b) Evaluation: These sketches are drawn by the sources during debriefing and are orientated to a 1:25,000 pictomap supplement to obtain grid coordinates. A visual reconnaissance of the area using handheld

CONFIDENTIAL

photography usually confirms the target location and the photographs are oriented to the pictomap supplement for the operation. This procedure enables the source as well as the case officer and the exploiting unit to be quite familiar with the exact location of the target and the terrain surrounding the target area.

(c) Recommendation: That commanders use sketches drawn by sources to assist them in pin-pointing the exact location of targeted areas.

(2) Tunnel exploitation methods.

(a) Observation: Tunnel exploitation methods have been learned and successfully applied during Sources/Liaison operations as well.

(b) Evaluation: A light observation helicopter should fly over the target area before ground elements arrive in the target area. This tactic has a tendency to force the enemy into tunnels which have been targeted. In many cases the enemy will flee the area if they believe they have been located. After the tunnel is located, a security element is posted around the general area of the target. A Kit Carson Scout or the source attaches a grappling hook over the trap door. Two personnel provide security for the source with small arms or automatic weapons. They use good cover protection in the event of hostile fire from the tunnel. These two security personnel are normally between 15 and 25 meters from the tunnel entrance. After a trap door is removed, a smoke grenade is thrown into the tunnel to locate possible exits and air holes and to determine the length of the tunnel. An interpreter, who could be one of the security personnel, attempts to induce the personnel inside of the tunnel to rally to the GVN. A megaphone is very useful at this point. When the tunnel is found to offer no immediate threat, a Kit Carson Scout or the source enters the tunnel looking for personnel, weapons and documents. By using a minimum of force to exploit the tunnel and having the main security element remain just outside of normal grenade range, friendly casualties can be kept to an absolute minimum. In past operations, the junior officer in the tactical unit actually exploited the tunnel while members of the tactical unit crowded around the tunnel entrance to observe what was to be evacuated. This was found to be very dangerous and costly.

(c) Recommendation: That commanders use this method or a similar method to exploit tunnels when conducting Source/Liaison operations.

(3) Interdiction of VC Tax collection efforts.

(a) Observation: Interdiction of VC Tax collection efforts has been successful by employing local civilian agents.

(b) Evaluation: A measure of success has been achieved in the inter-

CONFIDENTIAL

diction of Tax collection efforts by placing reliable agents in the rice fields. When contacted, the agent asked the collectors to return the next day to collect taxes. A daytime ambush utilizing snipers was set up which resulted in capturing the local VC Finance Chief. The agent used was the wife of one of the Kit Carson Scouts working for this unit.

(c) Recommendation: That local civilian agents be employed to obtain information about VC.

(4) Feed back of intelligence.

(a) Observation: Feed back of intelligence to the finding unit.

(b) Evaluation: When the individual soldier discovers enemy documents and materials he is very interested in its intelligence value.

(c) Recommendation: A readout of the information and its intelligence value should be sent to the finding unit as soon as possible. This is concrete evidence of the oft-elusive enemy and fosters a desire by the soldier to be even more observant.

(5) Enemy movement.

(a) Observation: The enemy will move during dawn and dusk periods when he knows US reconnaissance operations are not being conducted or ambushes in place.

(b) Evaluation: Air assets, properly employed, could be utilized to detect and engage enemy movement during the "gap" between ground reconnaissance and ambush operations. The following plan was adopted:

1 The brigade AO is divided into sectors and air assets are pooled. During the critical periods 0645-0800 and 1715-1915, all available assets are assigned specific search areas by brigade S2. These normally included, in the evening, 2 FAC's, assigned for high level surveillance in areas thought to be dangerous to low-flying aircraft; two light scout teams, assigned several smaller areas of known recent enemy activity; the Mini-Cav, on stand-by for insertion on targets of opportunity; and a Brigade Aviation LOH with command and control officer on board, to VR an assigned area until a target is acquired by a search element, at which time he proceeds to the scene of the engagement. Once on station he recommends to Brigade S3 the desirability of inserting the Mini-Cav. If the decision is made to insert, he commands and controls the insertion operation and extraction of the Mini-Cav.

2 Assets available in the morning are the same except for the deletion of one LST and the addition of one DIVARTY LOH. Excellent results have been obtained in terms of improved intelligence of trail and bunker

CONFIDENTIAL

activity as well as the engagement and destruction of a number of enemy.

(c) Recommendations: That maximum available air assets be utilized in a systematic manner to deny the enemy freedom of movement during dawn and dusk periods.

(6) Sensor targeting.

(a) Observation: Sound intelligence is needed to select profitable locations for sensors.

(b) Evaluation: Information was gathered from as many sources as possible as to patterns of enemy movement. These included frequent debriefing of FACs and AOs on the latest changes of trail indicators, solicitation of recommendations from maneuver battalion S2s for indicators noted during operations, and II readouts from photographic missions. PWs and Hoi Chanh were interrogated for specific information on routes normally followed and captured documents were read out to determine lines of communications and infiltration. Added to this was analyses of all types of sensory returns such as radar, SLAR, Red Haze, "Sniff" and Duffel Bags already implanted. By plotting information gained through all of these sources over a period of two weeks on drops to enable it to be seen together, a good perspective of recent enemy movement could be gained. A solid basis for targeting future sensors was the result, enabling the 2nd Brigade to implant over 101 active sensors during the reporting period.

(c) Recommendations: Sensors should be implanted at sites selected through analysis of as much intelligence information, from as many sources as possible.

(7) Coordinated targeting.

(a) Observation: Centralization of targeting should allow more profitable employment of assets.

(b) Evaluation: By making intelligence available to a larger number of potential users the brigade S2 has been able to recommend profitable targets for a greater variety of assets. Airstrike targets, Sniff areas, possible ambush sites, and guidance on radar employment are examples of areas where S2 can assist the commander in asset utilization by employing all available intelligence sources to determine enemy locations and movement.

(c) Recommendation: Full use should be made of S2s to provide targeting information for all assets.

(8) Quick reaction to small targets.

(a) Observation: A means was needed to react quickly to small,

CONFIDENTIAL

perishable targets provided by CI section, 25th MIC.

(b) Evaluation: Mini-Cav was found to be ideal for use on these targets. It has organic air support, including a light scout team, and can be inserted on a target with very little lead time. Also well suited to such operations are the CRIP Platoons of maneuver battalions, provided assets are available to insert on target, or if target location can be reached utilizing organic vehicles. Several successful operations were carried out, as illustrated below.

1 On 7 Jan 70 25th MIC targeted an area in Sa Nho (H) where 5 VCI were reportedly hiding. It was decided to utilize the Mini-Cav on the target as soon as possible thereafter. Insertion was made the next afternoon with a 25th MIC team attached. Source led element to a tunnel where contact was made, resulting in one VC KIA and two VC PWs.

2 On 16 Jan 70, 25th MIC identified a VC tax collector living in Lao Tai New Life Hamlet, Trung Lap (V). As this target was near a main road, it was decided to employ CRIP/2-14 Inf against this target. The operation was conducted on 18 Jan 70, resulting in the tax collector being captured.

(c) Recommendation: That Mini-Cav and Combined Reconnaissance Intelligence Platoons of maneuver battalions be utilized as quick reaction elements against small, perishable targets.

(9) Use of Kit Carson Scouts.

(a) Observation: Kit Carson Scouts (KCS) are particularly useful in contacting families of local VC to try to convince them to rally to the GVN.

(b) Evaluation: Interrogation of Hoi Chenh has in many cases revealed that their rallying was the result of being contacted by a Kit Carson Scout.

(c) Recommendation: Kit Carson Scouts should whenever possible be assigned in areas where they operated as Viet Cong. Additionally, more funds should be added to the Volunteer Information Program (VIP), so that scouts can be provided with an incentive to make contact with VC during off duty hours.

c. Operations.

(1) Search Operations.

(a) Observation: Troops experience difficulty of movement along creek banks due to mud, thick vegetation, and booby traps. Nevertheless, enemy caches are often located in these difficult areas.

84

CONFIDENTIAL

CONFIDENTIAL

(b) Evaluation: Sampans are used to assist search operations along waterways. The sampans enhance movement through the difficult areas while affording a more thorough search of the area. The sampans are painted on the inside with colors which contrast with the surroundings so that friendlies can be easily located and identified from the air. In addition, the Ordnance Locator, MK-15 Model O, Sperry-Rand-Manual Systems Division is used to probe the banks and the waterway itself for enemy caches. These ordnance locators are excellent for this type of operation because of their negligible bulk and lightweight characteristics.

(c) Recommendation: That two of the Ordnance Detectors be included in the infantry company's basic TOE because of their effectiveness and versatility.

(2) Sniper Employment.

(a) Observation: During the rice harvest, Binh Thanh villagers (XT340-180) reported to Brigade elements that enemy tax collectors were coming from Cambodia during the daylight hours to collect taxes from the farmers.

(b) Evaluation: Mechanized reconnaissance operations were conducted up to one kilometer from the border. During these operations, stay-behind sniper teams, each consisting of two snipers, one RTO and three Popular Force soldiers would be dropped off along likely crossing sites early in the morning hours. The teams would remain in location until dusk. The Popular Force soldiers identified the tax collectors while the snipers engaged at long range. According to the villagers, the combination of mechanized reconnaissance patrols and daylight stay-behind sniper teams greatly reduced enemy taxation from its previous levels.

(c) Recommendation: That mechanized reconnaissance patrols and stay-behind daylight sniper teams be used to reduce enemy taxation.

(3) Clandestine entry into bushmaster Area of Operations (AO).

(a) Observation: A major factor contributing to a successful bushmaster operation is the method of entry into the area.

(b) Evaluation: On one occasion an enemy reaction to a friendly method of operation provided a means of entering an area without alerting the enemy. The AO belonged to a mechanized battalion who had established a pattern of never operating far from their tracks. The enemy had observed this habit and became accustomed to the noise made by the approaching tracks and used it as a warning. A light infantry company was inserted into the area by tracks with the vehicle stopping at the drop off point only long enough for the troops to off load. The tracks then continued out of the area and the infantry moved toward their objective on foot. Within one hour the company's point element had spotted five enemy in the open area

CONFIDENTIAL

75 meters from their location and shortly thereafter engaged them. The light infantry company remained in the area for three days making a total of seven separate contacts and killed 21 of the enemy.

(c) Recommendation: That periodic cross attachment of tank, mechanized, and light infantry units be made to take advantage of any previous patterns established by friendly troops in a particular area and to keep the enemy off balance.

(4) Location of multi-squad sites using artillery marking rounds, compass, and M-16 plotting board.

(a) Observation: When engaged in bushmaster operations a rapid and accurate method is needed by the company commander of locating his squad-sized night ambushes (normally ten per company).

(b) Evaluation: A successful technique which has been developed involves the use of artillery marking rounds (WP 200 meter air burst) on selected grid intersections in the immediate area and the subsequent compass azimuth obtained by each squad to two or more of the WP rounds. The azimuths are then converted to back azimuths and plotted on the M-16 plotting board carried by the mortar FDC (the 81mm mortar platoon normally accompanies the company CP on bushmaster operations). By simple manipulation of the plotting board, a six digit coordinate can be rapidly obtained for each of the APs.

(c) Recommendation: That the M-16 plotting board-artillery marking round technique described above be disseminated to line units as a useful method of position determination when several sub-units are involved.

(5) Use of signal mirrors in airmobile operations.

(a) Observation: In several instances during the last quarter, the use of smoke grenades for pick-up zone (PZ) identification resulted in enemy mortar attacks. Smoke indicates for several thousand meters in all directions the exact location of the PZ. The use of colored marking panels has solved the requirement for a ground to air location indicator which is not visible except from above. However, because of the distance from the PZ that a normal helicopter approach is initiated and the angle of descent, it is sometimes difficult for the pilot to stay oriented on the marking panel. A signal mirror in combination with the colored marking panel has been tested and found extremely effective as a solution to the problem of PZ identification while making an approach.

(b) Evaluation: Two colored marking panels are placed at the head of each column on the PZ. The individual using the signal mirror stands near one of the panels, and on signal from the PZ commander, flashes the lead aircraft in the flight. This procedure is continued while the flight makes its turn to base and final. As the aircraft approach short final,

CONFIDENTIAL

the colored marking panels are raised from the ground and flashed at the aircraft to provide a final guide. Signal mirrors being directional in nature prevent unnecessary disclosure of friendly positions to enemy in the area. When used with colored marking panels they provide a highly effective, safe method of marking PZ locations for aircraft.

(c) Recommendation: That signal mirrors be made available through logistical channels and when possible their use be substituted for colored smoke to identify PZ locations for aircraft.

(6) Use of snipers in conjunction with a search light.

(a) Observation: Radar and other sensing devices are capable of picking up enemy movement around friendly positions, and within sniper range.

(b) Evaluation: Due to this capability, high intensity search lights should be employed around friendly locations and used in conjunction with snipers.

(c) Recommendation: When the enemy is located by a sensing device and within sniper range, the search light and sniper should engage the target at the same time.

(7) Contamination of garbage sumps upon closing of friendly installations such as fire support bases.

(a) Observation: The enemy likes to move into closed installations and pick up anything that he can use. He specifically likes to check old sumps since their contents often provide material for mines, booby traps, etc.

(b) Evaluation: Since the enemy likes to open these sumps some method should be employed to counter his action.

(c) Recommendation: Persistent CS riot control agent should be placed in all sumps before closing to discourage personnel from attempting to reopen them.

(8) Mutually supporting ambush.

(a) Observation: Since the early days of our involvement in the Vietnam war, commanders at all levels agree that the enemy does most of his moving and a great deal of fighting during the hours of darkness. In order to deny the enemy his freedom of movement that he has enjoyed for so long, units have been employing night offensive tactics in the form of night ambushes.

CONFIDENTIAL

(b) Evaluation: In the armored battalion's area of operations, Nui Ba Den has afforded the enemy an excellent staging and resting area. Because of the terrain surrounding the mountain is mostly cultivated rice fields, the mountain is most accessible at night. The ambush is commonly associated with infantry units, but for the past three months the 2-34 Arm has taken several qualities of this infantry night tactic and incorporated it into our armor structure. In the past, the sole tactic of armor units at night was a night defensive position or night laager where all vehicles were employed in a circle strictly for defensive purposes. This type of night defensive tactic has been replaced by one where the companies are broken down into four or five ambush sites which provide good fields of fire and are mutually supporting. The number of sites depends upon the number of vehicles available. The vehicles are placed in a triangular configuration usually composed of two tanks and one armored personnel carrier so as to obtain all around security and fields of fire. This tactic has been very successful and in one instance resulted in confirmed 15 NVA eliminated.

(c) Recommendation: Recommend that armor night defensive operations in the form of mutually supporting armor ambushes be considered when the situation is feasible. This tactic denies the enemy free movement at night while providing a more complete saturation of the area.

(9) Employment of an Armored Cavalry Platoon.

(a) Observation: Armored operations in Vietnam are hampered by the inherent lack of security elements provided by the TO&E of the armored battalion.

(b) Evaluation: For 30 days during this reporting period one platoon from a cavalry unit was OPCON to a tank company and one tank platoon went to the cavalry. During the 30 day period, the cavalry platoon with its seven APCs and three M551 Sheridans proved to be an excellent fire and maneuver element. It provided the tank company with the added flexibility that it has long required. The dual infantry-armor capabilities inherent within the cavalry structure were most valuable to the tank company in its reconnaissance in force operations. In all aspects of its operation, the armor-cav mix proved to be advantageous.

(c) Recommendation: Further studies should be made of armor operations in Vietnam to determine a more flexible TO&E structure so that the armor battalion and its tank companies will be able to use their firepower, shock-effect, and maneuverability to maximum advantage.

(10) Kit Carson Scouts employed with sweep teams.

(a) Observation: Units often have the mission of opening roads. Kit Carson Scouts attached to the unit in most cases have operated in that units AO before becoming a Hoi Chanh. This individual can be of great assistance

CONFIDENTIAL

in detecting mines and booby traps if employed with a sweep team.

(b) Evaluation: On 10 October 1969, Highway T14 was to be swept for the first time in almost three weeks. There was a report that 10 to 15 mines had been placed in the road. It was decided that a Kit Carson Scout should be employed with the sweep team since he had worked the area before and knew some of the likely mine locations. Over a period of four hours he found four 25 pound antitank mines while the sweep team only found one. Kit Carson Scouts have since been used on most road sweep missions accounting for over 80% of all mines found.

(c) Recommendation: Recommend the continuous use of Kit Carson Scouts to assist engineer sweep teams in detecting mines and booby traps. In many cases the Kit Carson has placed mines and booby traps in roads while an enemy and knows much about enemy tactics in a given area.

(11) Use of APCs as a direction reference point.

(a) Observation: The individual soldier normally does not have a compass and therefore does not have an accurate means of reporting sightings at night. This lack of means to determine direction could cause a costly delay in the placing of supporting fires on the enemy.

(b) Recommendation: That tracks in a NDP be positioned to face a certain direction and that this direction be passed to each individual so as to provide a ready reference point for direction. Example: The command track is facing north.

(12) Maximum benefit from the Duffel Bag Program.

(a) Observation: The sensors implanted in areas of heavy enemy activity have provided us with a means of detecting his movement without having to place troops in the area. Prompt reaction by artillery or mounted patrols is important if this technique is to be used to maximum advantage.

(b) Evaluation: Rapid reaction to duffel bag activations can be accomplished by posting a monitoring team on the same fire support base as the artillery battery which will cover the sensors in their firing range. All data for each sensor location should be precomputed and blanket clearance should be obtained as soon as curfew is imposed in the monitored area. Command emphasis should be placed so as to insure that the lead time from sensor activation to first round on target is at an absolute minimum.

(c) Recommendation: That the receiver for duffel bag sensors within a fire support base AO be placed at that FSB and that all data for each sensor location be precomputed and blanket clearance be obtained as soon as curfew is imposed in the monitored area.

CONFIDENTIAL

(13) Quick reaction to communist mortar shelling of GVN hamlets.

(a) Observation: Frequently the VC will mortar a hamlet. In some cases this will cause friendly casualties or property damage.

(b) Evaluation: When such tragic events occur it necessitates a quick psychological reaction. Such a quick reaction when properly organized (Medcaps, Psyops) will help to win over VC sympathizers to the GVN cause. It will also help to publicize the destructive aims of the Viet Cong.

(c) Recommendation: A Medcap Team and a Psyops Team should always be ready to exploit a Viet Cong initiated incident.

(14) Use of Armed Propaganda Teams.

(a) Observation: Armed Propaganda Teams (APT) are extremely useful in seeking out information about Viet Cong activities. They offer living proof that a Chieu Hoi in fact does receive assistance and a chance for a useful life.

(b) Evaluation: APTs are useful when given a proper orientation on what is to be done when on an operation. They do produce intelligence. They are valuable in conducting effective psychological operations.

(c) Recommendation: The use of APTs should become an integral part of every unit's psychological operations program.

(15) Use of snipers on ambushes.

(a) Observation: Ambushes initiated on personnel more than 50-60 meters from the ambush site are ineffective.

(b) Evaluation: Snipers can be employed in ambush sites to engage targets which appear outside the ambush kill zone.

(c) Recommendation: That ambush patrols be reinforced with a sniper or snipers with the mission of engaging targets which appear outside the ambush kill zone.

(16) Use of Organic Mortars to support Night Operations.

(a) Observation: Immediate illumination and fire support is not always available during night operations when supporting artillery is engaged in firing other targets.

(b) Evaluation: Organic mortars are constantly laid on defensive targets for friendly positions and can provide immediate illumination and fire support.

CONFIDENTIAL

(c) Recommendation: Organic mortars should be displaced to forward secured bases to provide illumination and fire support.

(17) Night Offensive Positions.

(a) Observation: Night offensive positions (NOPs) must often be occupied with very limited fields of fire and observation.

(b) Evaluation: The occupation of NOPs with limited fields of fire and observation requires an extended clearing effort. Occupation must begin early to effectively clear fields of fire.

(c) Recommendation: That units request and utilize either a Combat Engineer Vehicle or Bulldozer to assist in clearing adequate fields of fire.

(18) Cavalry Operations Utilizing the M-48A3 Tank.

(a) Observation: During the period 30 Nov - 27 Dec 69, one tank platoon, 3/A/2-34 Arm, was attached to the 3rd Squadron, 4th Cavalry to evaluate the capabilities and limitations of the M-48A3 tank in Cavalry roles in RVN.

(b) Evaluation: The tank platoon was given road clearing, blocking force, detail search, reconnaissance and night mobile ambush missions. Conclusions were as follows:

1. Both vehicles, the M551 Sheridan vehicle organic to the Cavalry Squadron and the M-48A3 tank, can perform the Cavalry mission in RVN.

2. The M-48A3 has more staying power.

3. The M551 is more adaptable to the terrain and weather of RVN.

(c) Recommendation: That the M551 Sheridan be retained in the Cavalry Squadron in Vietnam.

d. Organization

(1) Improvement of "Night Hawk" Techniques.

(a) Observation: Through the introduction of a Night Hawk Platoon we have developed a more efficient and capable weapons system.

(b) Evaluation: The Night Hawk Platoon consists of a mini-gunner and light operator for each of our three Night Hawk helicopters. By having these individuals used solely for the purpose of operating the Night Hawk equipment, better maintenance is pulled on the equipment during the day,

CONFIDENTIAL

and more proficient, capable personnel are on the mission at night. Additionally, a new type gun carriage and ammunition carrier has been developed by the 34th Transportation Group which greatly facilitates the handling of the gun. A gravity fed ammo feed system was also fabricated using an LOH ammunition box, thus reducing the space required by the old system. In addition, the mini-gun was hooked up to a control box from the LOH system, reducing the rate of fire from 4000 to 2000 rounds per minute, and greatly increasing the life of the mini-gun barrels. During the month of December 1969, one month after the formation of the platoon, the effectiveness of the mission was exemplified by the elimination of 13 enemy.

(c) Recommendation: The above organizational and equipment modifications should be implemented in all units performing Night Hawk missions with an eye toward a more efficient, capable weapons system.

e. (U) Training.

(1) Ambush Patrols.

(a) Observation: One battalion experienced difficulty with ambush patrols. The reasons appeared to be improper preparation and lack of confidence.

(b) Recommendation: The battalion established a two-day ambush school and instructed each rifle platoon in the battalion as a unit. The first day consisted of classroom instruction on the preparation and conduct of patrols. The first night was devoted to night firing. It was discovered that several new soldiers had never seen a Claymore mine fired. The second day included the preparation for an actual patrol which was conducted the second night. The battalion now insures that adequate time (one full day where possible) is allowed for units to prepare for ambush patrols. In addition, by using various means of insertion, every effort is made to make each mission unique. As a result of these measures, performance on ambush patrols is steadily improving.

(2) Test Firing.

(a) Observation: Some units test fire their weapons by firing them into a ditch prior to departing on an operation, thereby missing an excellent opportunity to train their troops.

(b) Recommendation: Targets, to include those for night firing, can be fabricated out of ammunition boxes or C-ration boxes. These should be placed outside the perimeter and fired upon whenever weapons are test fired. Units should use every opportunity to have their troops fire their weapons. This increases confidence in the weapon, and at the same time causes ammunition to be rotated.

CONFIDENTIAL

(3) Night Operations.

(a) Observation: VC/NVA forces have ceased to mass and move in large groups during daylight, but continue to move in groups of 3-30 personnel during hours of darkness.

(b) Evaluation: VC/NVA movement has been detected at night for resupply, repositioning of troops and communications. The use of reconnaissance by Cavalry units during daylight has resulted in few enemy contacts.

(c) Recommendation: That continued emphasis be placed on night operations.

(4) Personnel Firing During Hours of Darkness.

(a) Observation: Personnel continued to fire weapons above the target when engaging during hours of darkness.

(b) Evaluation: Targets can not be effectively engaged during night operations unless every member of the team is properly trained in the proper techniques of night firing.

(c) Recommendation: In addition to normal platoon night firing exercises, all replacement personnel should, as soon as possible after joining their unit in the fire support base be required to participate in night firing exercises. Use of tracer ammunition is effective during night operations.

(5) Land Navigation.

(a) Observation: Personnel have a tendency to rely on memory when navigating through familiar terrain.

(b) Evaluation: Due to Rome Flow operations and the burning of wooded areas during the dry season, terrain may appear different than on previous operations in the same area.

(c) Recommendation: That during operations, commanders emphasize the difference in terrain features which have been destroyed or changed since personnel were last in the area. A compass, azimuth, and pace method must be used for navigational checks even when working in familiar terrain.

f. (U) Logistics.

(1) Generating Plan, 100TC - 8xH/6325R

CONFIDENTIAL

(a) Observation: During September 1969 the 25th Infantry Division received 5 each 10kw generators, skid mounted and 1 each 5kw diesel generator, skid mounted from the Mobility Research and Development Center, located at Fort Belvoir, Virginia for a six month suitability test. During the six month test the only parts that failed and required organizational maintenance were the two hourmeter gauges and one cracked muffler assembly. No DS maintenance was required. The generators were sent to the 125th Signal Battalion for the testing and the 125th Signal Battalion in turn sent the generators to various fire support bases where a true test could be conducted under adverse conditions of extreme dust and heat. The generators were run for 12 hours at a time for a period of eight weeks and then continuously for 23 hours a day per day with 1 hour down time for maintenance which consisted of cleaning the air filter. Engine oil was changed every 100 hours, oil filter at 375 hours and fuel filter cleaned at 100 hour intervals.

(b) Evaluation: Experience with conventional gasoline generators revealed that it is not uncommon to replace as many as 3 engines within 2500 hours of operation as compared to the diesel engine which now have as many as 3800 hours and are still in excellent operating condition..

(c) Recommendation: That the Onan 10DJC - 8xK/6235R replace the current 10kw gasoline driven generators now in use.

(2) Malaria.

(a) Observation: In operating on Nui Ba Den between 4 Jan and 11 Jan 70, ten (10) cases of Falciparum and two cases of Vivax Malaria were contracted.

(b) Evaluation: Operations were undertaken in an area of high malaria incidence with inadequate preventive measures being taken to guard against malaria.

(c) Recommendation: Future operations in areas of high malaria incidence should be preceded by instruction of proper personal protective measures. Chemoprophylaxis with Dapsone of personnel entering areas of suspected high Falciparum malaria incidence should be instituted during and for 28 days following exposure in these areas.

(3) Materiel Failure in the MK45 aerial illumination flare.

(a) Observation: During the period 26 November through 15 December 1969 we experienced a dud rate in the MK 45 aerial illumination flare in excess of 80%.

(b) Evaluation: Initially we surmised the basic cause factor to be a bad ammunition lot, and suspended the lot of MK45 flares currently in use.

CONFIDENTIAL

Upon examination of the flares in the lot, it was noted that an excessive amount of condensation had accumulated inside the impermeable polyethylene bags in which the flares were packed; thus ruining the flare candle and rendering the munition ineffective. A packing fault was obviously a causative factor. However, the major factor was judged to be improper storage and maintenance of the flare munitions. The munitions were at the time stored in the open and uncovered.

(c) Recommendation: Storage facilities for the MK45 aerial illumination flares should be improved to include the provision of palleting materials to maintain the munitions well clear of the ground, and overhead cover should be provided to protect the flares from the elements.

(4) Weapon inspection for turn-in or repair.

(a) Observation: Inherent in all combat situations involving armored units with their large number of heavy automatic weapons is the need for a speedy repair and replacement system for both individual and crew-served weapons.

(b) Evaluation: Each company within the battalion has scheduled standowns usually one month apart. Because of the heavy use of all weapons on the tanks many of them are in constant need of repair. In order to run a check on the weapons, contact teams from a forward support unit have been scheduled to check all weapons in the companies during the standdown period. In the past the teams only inspected the weapons, and then determined what parts and repairs were necessary. The company armorer then requisitioned the needed repair parts. This process resulted in the weapon being deadlined from 30 to 60 days depending on the length of the requisition delivery period.

(c) Recommendation: To prevent the loss of weapons for an unnecessarily lengthy period, the contact teams should inspect the weapons and repair them on the spot, and at the same time they should determine if any of the weapons should be turned in.

(5) PLL kits for OFCON platoon.

(a) Observation: Maintenance support of OFCON tank platoons is

CONFIDENTIAL

difficult to accomplish as units receiving the tank platoon most often do not have the capacity to provide needed maintenance.

(b) Evaluation: To overcome the lack of sufficient maintenance facilities of units receiving OPCON tank platoons a PLL kit containing a cross section of commonly needed parts was assembled and is sent with the tanks to the OPCON unit. A complete powerpack is already assembled and set aside in case the platoon should have need of it. If a new track is needed, it is assembled at the FSB and air lifted to the platoon's location so as not to lose valuable time assembling tank track. Daily calls to the OPCON unit are made to determine if any parts need to be replaced in the PLL kit. The PLL Kits and standby items have cut down considerably on the deadline time of the platoons thus helping keep the unit fully combat effective.

(c) Recommendation: All armor and mechanized units consider making up PLL kits to send with a unit which is OPCON to another unit not having the maintenance capability to support mechanized equipment. This PLL kit should contain enough spare parts to keep the unit running until repair parts can be delivered.

(9) Field transportation of Class III Items.

(a) Observation: The mechanized infantry battalion is authorized only wheeled vehicles to transport Class III supplies. This method of movement is inadequate when it is necessary to take POL into limited access areas such as night defensive positions.

(b) Recommendation: Two 600 gallon collapsible POL bladders be mounted on an M-548. With a bilge pump run from the M-548's batteries, and a sufficient base, the refueling unit is complete. A system of this nature allows Class III to go wherever the M-113A1 goes.

g. Communications: None

h. Materiel: None

i. Other:

(1) CAVCAP.

(a) Observation: Success of the Combined American-Vietnamese Civic Action Program (CAVCAP).

(b) Evaluation: The principal objective of any Civic Action Program is to gain support for the local Vietnamese government from the populace. This objective can best be achieved by allowing the local government to take an active part in all civic action programs initiated

CONFIDENTIAL

by the United States. Success in this area is evident by allowing the Vietnamese S-5 and the Vietnamese Information Service at district level to participate in the traditional MEDCAP program, which is now called the Combined American-Vietnamese Civic Action Program. The Vietnamese S-5 organizes a weekly CAVCAP program. The Vietnamese medics from the district dispensary actually perform all medical treatment needed by the populace and the Vietnamese Information Service has representatives present at all the CAVCAP sites. These representatives release news items to the people by means of a public address system and by distributing leaflets and posters to the audiences. Thus, the local Vietnamese government has maximum participation in the CAVCAP program. This concept allows the populace to actually see their local government performing all the vital functions of the program. While the local government is extending aid to the populace through the medical program, they are also gaining the support and admiration of the people.

(c) Recommendation: That all unit S-5 officers allow the local Vietnamese government maximum participation in civic action programs initiated by US units.

(2) Leaflet Development.

(a) Observation: During the reporting period, leaflets developed by ACofS, G5 often included hand drawings by a Vietnamese interpreter/artist that depicted scenes congruent with the message on the reverse side of the leaflet.

(b) Evaluation: It was discovered from Hoi Chanh interviews that these drawings were often offensive to the enemy as the drawings of the enemy soldiers often depicted the enemy soldier as being skinny and undernourished. Since this was not necessarily descriptive of the typical enemy soldier, it detracted from the overall credibility of the message.

(c) Recommendation: When attempting to reach a target audience through the use of pictorial drawings, caution must be exercised to ensure the drawing is descriptive of reality rather than congruent with our beliefs and aspirations.

(3) Pre-flight and Post-flight Inspections:

(a) Observation: With aircraft and crews maintaining a constant strip alert (notification of mission to airborne within three minutes) the conduct of proper pre-flight and post-flight inspections becomes, at best, questionable.

(b) Evaluation: A system which has proven most effective in discovering defects and/or battle damage is as follows: The crew chief allows adequate time prior to assuming scramble status to perform his

CONFIDENTIAL

daily inspection and fill out forms and records. The pilot is present at the aircraft 45 minutes prior to scramble status to perform his pre-flight. The aircraft commander arrives 30 minutes prior to scramble status to perform his pre-flight. This procedure affords three people the opportunity to scrutinize the aircraft prior to flight. On post-flight the reverse procedure should be employed.

(c) Recommendation: In order to alleviate the possibility of aircraft deficiencies or battle damage going undetected, it is recommended that the above procedure be implemented by crews of aircraft subject to scramble type missions.

(4) Confusion and Congestion at downed aircraft locations.

(a) Observation: The critical situation which exists at any crash site or location of downed aircraft is often reduced to near chaos by the presence of too many well meaning aircraft and crews moving into the area to be of assistance. The resulting confusion, congestion and near total lack of proper control renders the situation in the air nearly as tenuous as the one on the ground, and seriously detracts from the effective conduct of search and rescue operations.

(b) Evaluation: The first aircraft over a crash site should take control of the operation and declare himself mission commander. He will remain in this capacity until relieved by the unit commander or his representative. The aircraft commander should make a call on a specific control frequency or guard frequency giving grid coordinates, type of aircraft involved and identification; general situation, and intentions. The control ship should then designate a fire team, if available, and a specific aircraft to execute extraction of crew members from the site. After extraction is complete the fire team may be retained for subsequent extraction operations of the aircraft itself. Once the rescue sequence is initiated it is inadvisable that control be transferred until such time as crew rescue and extraction is complete. In the event of an aircraft crash, location unknown, the control ship should assign sectors of search to aircraft as they come on station. Aircraft not necessary to the search and rescue effort should be held clear of the area at designated orbit points and altitudes.

(c) Recommendation: By using the above mentioned procedures as guidelines, the processes of search and rescue operations, crew and aircraft recovery will be greatly enhanced, while minimizing the danger of mid-air collision, congestion and confusion.

(5) Night approaches to areas with minimal lighting.

(a) Observation: A recent major aircraft accident occurred at night while the aircraft was in a tight, shallow circling approach to a landing zone marked by a single, flashing strobe light.

CONFIDENTIAL

(b) Evaluation: Night approaches require a high degree of alertness, and should be made by utilizing a standard traffic pattern approach. Airspeed should be maintained. Final approach should be at a steeper-than-normal approach angle. The landing light should be utilized as much as possible to facilitate lighting of the landing zone, and safe touchdown.

(c) Recommendation: Night approaches should be standardized within the unit. The aircraft commanders and unit instructor pilots should closely monitor night operations for the detection of unsafe procedures.

(6) The wearing of fire retardant, nomex flight clothing.

(a) Observation: Shortage of nomex clothing and the incorrect wearing of the garment by those who do possess them is of paramount concern to the Division Safety Officer and the Division Flight Surgeon.

(b) Evaluation: A recent battalion safety meeting was devoted to reintegrating the numerous advantages of the proper wear of nomex clothing when engaged in flying duties. The point was made by illustration of the effects of fire on skin areas not covered by nomex. The point was further dramatized by one individual who recently escaped an aircraft fire without injury, due to the fact that he was wearing nomex and wearing it properly.

(c) Recommendation: That procurement and wear of nomex flight clothing for all aviators engaged in flying duties should be mandatory. A central issue facility (CIF) should be established for aviation flight clothing and associated gear to assure that it remains in proper channels.

(7) Field expedient grappling hook.

(a) Observation: The use of grappling hooks in booby trapped areas has proven to be an effective means of clearing an area. However, grappling hooks are difficult to obtain through normal supply channels.

(b) Recommendation: Field expedient grappling hooks can be made by utilizing large, heavy gauge nails or concrete reinforcing rods which can be shaped and welded together to form a three pronged hook. A few links of chain can be welded to the hook to provide an anchor point for a rope.

(8) Penepine distributor availability.

(a) Observation: Now the dry season has started; there is a need for dust control.

(b) Evaluation: Preliminary investigation indicated a shortage of TO&E bituminous distributors. Available distributors are used solely for MSRs. This situation has left fire support bases, patrol bases, and

CONFIDENTIAL

battalion areas without a dust control means.

(c) Recommendation: Each maneuver battalion be informed of a method of constructing expedient penneprine distributors. A 1½ ton utility trailer or even a ½ ton trailer could be used.

(9) Drainage of large pot holes.

(a) Observation: During the past rainy season the engineers have experienced difficulty in draining standing water from the roads which were being upgraded.

(b) Evaluation: Preliminary investigation indicated the standing water was lower than surrounding terrain. If pumped out the water would flow back into its initial location. Since fill had to be placed for a new road bed, the water had to be removed.

(c) Recommendation: Several methods were used to eliminate the water. First a reinforced 55 gallon drum was attached to the bucket of a front loader and used as a "dipping pail". This was a good solution but slow. Since time was important in repair, cratering charges were set off the sides of the road to create an artificially lower elevation. Also demolition cord and C-4 were used to open ditches to the crater. The crater and ditches were blown simultaneously so the road water would run off before the rice paddies high water table could seep into the crater. After water had flowed into the crater, the ditch was closed using hand shovels to prevent reversal of water flow direction. This gave a quick and immediate solution so the road could be repaired.

(10) Testing for trafficability.

(a) Observation: The engineers had experienced difficulty during the rainy season with poor trafficability, especially with D-7 tractors.

(b) Evaluation: Preliminary investigation showed the main cause for vehicles becoming stuck was a lack of knowledge of underlying soil conditions. The soil would look firm but when concentrated loads were applied the crust-like surface would break. In some instances several vehicles would pass over the same terrain and a vehicle following would break the crust-like surface.

(c) Recommendation: To eliminate guesswork and because a cone penetrometer was not available, all personnel in charge of equipment were instructed to build an expedient testing device. This consisted of a bullet-nosed steel rod 3 to 4 feet in length with a "T" handle for pushing the rod into the soil. With some practice and experimentation, soil could be tested for trafficability. If the rod could be pushed through crust-like surfaces, then soil conditions became known.

CONFIDENTIAL

In this manner a complete route could be selected for heavy equipment and guesswork would be eliminated.

(11) Expedient grader for clearing brush.

(a) Observation: Maneuver battalions supported by this unit have had requirements to clear fields of fire at their fire support bases because of regrowth of vegetation.

(b) Evaluation: Since grader and bulldozer use had been committed to higher priority tasks, the supported elements had been left with the task. Brush and tall grass had to be removed to facilitate observation.

(c) Recommendation: Any 2½-ton or larger vehicle or track (APC) that was available at the fire support base could be utilized for pulling a steel "I" beam as a drag. Areas were cleared between defensive wires so this vehicle could pass through. Periodically during the month the drag could be pulled, canted at a 30 degree angle of perpendicular to the direction of pull, around the defensive area. After several trips, the surface soil would be leveled and all brush and grass removed.

(12) Lifts of laterite placed on existing roadways.

(a) Observation: Lifts compact but do not bind well to existing road surfaces, especially when put down on a dry road during rainy weather.

(b) Evaluation: The strata caused by non-binding of lifts causes the lifts to break up and form dust under traffic during the dry season and will cause them to slip off the road during rainy weather.

(c) Recommendation: Adequate scarifying capability should be provided either by graders or dozers equipped for scarifying whenever laterite is to be applied to an existing road. After the scarifying is complete, the road should be wet before compaction.

(13) Consistent use of the same vehicle turn-around point.

(a) Observation: It has been noted that the enemy will mine areas that units use daily as turn-around points.

(b) Evaluation: Day to day use of the same turn-around points are certainly noted by the enemy and may dictate to them the location for mine or booby trap placement.

(c) Recommendation: Do not use the same vehicle turn-around point consistently without a thorough prior sweep of the area.

(14) Repair of broken mine detector handles while on sweeps.

101
CONFIDENTIAL

CONFIDENTIAL

(a) Observation: On minesweep operations, the handles are sometimes accidentally broken, causing a delay in the mission.

(b) Evaluation: Sweep teams should be prepared to repair damaged detection equipment if possible in order to continue with the mission.

(c) Recommendation: Sweep teams should take all necessary precautions to prevent damage to mine detectors. In the event a handle is broken, it is often helpful to have a roll of black electric tape to aid in making a splint for the handle.

(15) Improvement of the Naval Anchor Chain.

(a) Observation: It was determined that rods welded on the anchor chains used on land clearing would improve the complete detonation of booby traps and plow mines out of the ground.

(b) Evaluation: An experiment with the rods welded on the chains proved to facilitate the land clearing mission.

(c) Recommendation: That units using heavy Naval Anchor Chains should weld rods on each link of the chain allowing approximately six inches of the rod to protrude past the limits of the chain link.

(16) Use and capabilities of the Combat Engineer Vehicle.

(a) Observation: During the last reporting period this unit has monitored the CEV doing extended operations at Nui Ba Den, Ho Bo Woods and Top Hat. During these operations the CEV was used for the following types of tasks:

- 1 Slot dozing APC positions.
- 2 Pushing up berms for night laager positions.
- 3 Bull blade used to destroy bunker and tunnel positions.
- 4 Bull blade used to destroy hedgerows, banana groves and vegetation.
- 5 Bull blade used to open and close garbage dumps.
- 6 CEV was used to clear fields of fire.
- 7 The winch was used to retrieve vehicles.
- 8 The 165mm gun was used to engage bunkers and caves up to 1400 meters in range.
- 9 White light capability was used for illumination.

CONFIDENTIAL

10 As a trail blazer for the M551 Airmobile Assault Reconnaissance Vehicle (Sheridan).

(b) Evaluation: The CEV bull blades were found to be very effective against bunkers and tunnel complexes. The main gun is a highly accurate weapon once it is zeroed. The CEV can be effectively used as long as supported units realize it is not a tank or bulldozer. In areas of poor trafficability the CEV will experience some difficulty due to its enormous weight. A recurring problem on operations was the loss of several "push beam pins" on the bull blades. Each CEV has a total of six of these pins which sometimes become lost due to vibrations and rough terrain. The effectiveness of the CEV's .50 caliber machine gun is minimized when personnel ride on top of the CEV. Proper and daily maintenance is a must, if the CEV is to operate effectively.

(c) Recommendations:

1 Since the CEV is very heavy and becomes mired in poor trafficable soil, it is suggested that at least two CEVs be utilized on an operation. The CEV is too heavy to be retrieved by a vehicle smaller than a CEV or VTR.

2 Because the bull blade hampers the CEV's movement when mired, it is recommended that the CEV be backed across soft areas.

3 When a CEV is being towed in an attitude other than straight and level, the tow cable will generally run across the sharp edges of the bull blade. For this reason, blocks of hardwood six inches by six inches should be carried to place between the cable and the bull blade.

4 To prevent the loss of "push beam pins" this unit has modified them. If the modification proves effective, a DA Form 2407 will be submitted requesting a modification for all CEVs.

5 When clearing hedgerows the CEV should be buttoned up to preclude injuries from booby traps in the brush.

6 When firing the 165mm gun at solid objects such as rocks or metal, everyone should be protected because shrapnel will travel approximately 800 meters.

7 The CEV is not a bulldozer and should not be used extensively for land clearing or normal dozer usage.

8 The supported units have nothing but praise for the CEV. The effectiveness of the 165mm demolition round is of great value when used to fire on houses, bunkers and caves and the bull blade is also effective when pushing up small berms and small land clearing missions. It is recommended that all combat engineer units operating in an area with traffica-

CONFIDENTIAL

bility suitable for the CEV be issued this piece of equipment.

9 It is recommended that the CEV not be used as a trail blazer in terrain such that the brush is four to five feet high. Improper use resulted in replacement of 14 road wheels, two torsion bars and two tracks on one CEV.

10 It is recommended that the transmission be redesigned to allow full capability of the blade. The piece of equipment is deceiving looking; it will not do what it looks as if it could do, therefore is grossly misused.

(17) Combined American-Vietnamese Civic Action Program.

(a) Observation: PSYOP Civic Action Programs continued with increased emphasis on ARVN initiated projects and MEDCAPS. Development of a propaganda team (APT), using two to three KCS assigned to a battalion is an effective means of gathering information. During MEDCAPS they operate in the village (hamlet) seeking intelligence and visiting the families of suspected VC to explain the Chieu Hoi Program and to encourage rallying. It is recommended that these scouts have some fluency in English and possess the necessary motivation. Employment of the 250 watt loudspeaker set in Cu Chi district ARVN compounds was initiated using live and taped broadcasts. The set afforded the hamlet, village and district chiefs an opportunity to prepare special interest tapes relating to their particular area of interest.

(b) Evaluation: The principal objective of any civic action program is to gain support from the populace for the local Vietnamese government. This objective is being achieved by allowing the local government to take an active part in all civic action programs initiated by Allied forces. Success in this area is evident by allowing the Vietnamese S5 and the Vietnamese Information Service at the District level to participate in the traditional MEDCAP program. Currently in Khiem Hanh, the Vietnamese S5 organizes a weekly MEDCAP program. The Vietnamese medics from the district dispensary actually perform all the medical treatment needed by the populace. The Vietnamese Information Service (VIS) has representatives present at all MEDCAP sites. These representatives release news items to the people by means of a public address system and by distributing leaflets and posters to the audience. Thus the local Vietnamese government has the maximum participation in the MEDCAP Program. This concept allows the populace to actually see their local government performing all the vital functions of the program. While the local government is extending aid to the populace through the medical program, they are also gaining the support and admiration of the people.

CONFIDENTIAL

(c) Recommendation: That all unit S5s continue close coordination with the ARVN S5 to allow the local Vietnamese units and government organization maximum participation in civic action programs initiated by US units.

FOR THE COMMANDER:

JAMES M. CONNELL
Colonel, GS
Chief of Staff

Inclousures

1. Troop List
2. Commander's Combat Notes
(Sniper Operations)
3. Commander's Combat Notes
(Employment of CS to Capture PWs)
4. Observations of a Mechanized
Company Commander
5. Communist Sapper Attack
(VC Sapper Tactics)
6. Treatment of Prisoners and
Detainees
7. The MDH-5 Miniature Fixed
Directional Mine
8. Air Cavalry Package (Mini-Cav)
- ~~9. Boundary and Task Organization
Changes~~
10. Combat After Action Report
(1st Platoon, Company B, 1st
Battalion, 27th Infantry)
11. Combat After Action Report
(Operation Cliff Dweller IV)

Incl 9 wd HQ, DA

DISTRIBUTION:

- 4 - CG, IIFV, ATTN: AVVBC-RE-F
- 3 - CG, USARV, ATTN: AVHGC-(DST)
- 2 - CG, USARPAC, ATTN: GPOP-DT

105

CONFIDENTIAL

AVFBC-RE-H (1 Feb 70) 1st Ind
SUBJECT: Operational Report - Lessons Learned, 25th Infantry Division,
Period Ending 31 January 1970, RCS CSFOR - 65 (R2)

DA, HQ II FFORCEV, APO San Francisco 96266 13 MAR 1970

TO: Assistant Chief of Staff for Force Development, Department of the
Army, Washington, D.C. 20310

This headquarters has reviewed and concurs with the Operational Report -
Lessons Learned of the 25th Infantry Division for the period ending 31
January 1970.

FOR THE COMMANDER:

W. C. BARTEL JR.
CPT AGC
Asst AG

CONFIDENTIAL

AVHGC-DST (1 Feb 70) 2d Ind
SUBJECT: Operational Report - Lessons Learned, 25th Infantry Division,
Period Ending 31 January 1970, RCS CSFOR - 65 (R2)

Headquarters, United States Army, Vietnam, APO San Francisco 96375 30 MAR

TO: Commander in Chief, United States Army, Pacific, ATTN: GOPP-DT,
APO 96558

1. (U) This headquarters has reviewed the Operational Report-Lessons Learned for the quarterly period ending 31 January 1970 from Headquarters, 25th Infantry Division and concurs with the comments of indorsing headquarters.

2. (C) Comments follow:

a. (C) Reference item concerning "Pin-Pointing Target Areas", page 81, paragraph b(1): concur. Every means available must be taken to pin-point the exact locations of targeted areas to allow tactical elements to fully exploit a target. Item has been extracted for possible inclusion in the next issue of the USARV Combat Intelligence Lessons. No action by DA or USARPAC is recommended.

b. (C) Reference item concerning "Tunnel Exploitation Methods", page 81, paragraph b(2): concur. Item has been extracted for consideration for inclusion in the next issue of the USARV Combat Intelligence Lessons.

c. (C) Reference item concerning "Feed back of Intelligence", page 83, paragraph b(4): concur. Feedback of readout information of captured documents to capturing units is a positive manner of inducing units to be more observant and to facilitate processing of documents. Units see a result of their efforts and realize that the documents are being evaluated and used. Item has been extracted for consideration for inclusion in the next issue of the USARV Combat Intelligence Lessons. No action by DA or USARPAC is recommended.

d. (C) Reference item concerning "Sensor Targeting", page 84, paragraph b(6): concur. Unless sensor string locations are based upon sound intelligence, maximum benefit will not be derived. Intelligence information must continually be updated and analyzed to determine shifts in enemy movement patterns and the location of existing sensor strings evaluated. Item has been extracted for consideration for inclusion in the next issue of the Combat Intelligence Lessons. No action by DA or USARPAC is recommended.

e. (U) Reference item concerning "Search Operations", page 85, paragraph c(1). Recommendation that Ordnance Locator, MK-15 be included on infantry company MTOE is under consideration and equipment is currently being field tested in RVN. USARV message 120004Z Dec 69 stated the 25th Infantry Division would receive 24 Ordnance Detectors for combat operational evaluation. Upon completion of the evaluation and acceptance of the equipment, USARV will recommend appropriate MTOE action.

CONFIDENTIAL

107

**DOWNGRADED AT 3 YEAR INTERVALS;
DECLASSIFIED AFTER 12 YEARS.
DOD DMR 5200.10**

CONFIDENTIAL

AVHGC-DST (1 Feb 70) 2d Ind
SUBJECT: Operational Report - Lessons Learned, 25th Infantry Division,
Period Ending 31 January 1970, RCS CSFOR - 65 (R2)

f. (U) Reference item concerning "Use of Signal Mirrors in Airmobile Operations", page 87, paragraph c(5): concur. An item suitable and available to meet requirements of this recommendation is MIRROR, EMERGENCY, FSN 6350-261-9772, COST: \$1.97.

g. (U) Reference items concerning "Sniper Employment", page 86, paragraph c(2); "Use of Artillery Marking Rounds", page 87, paragraph c(4); "Mutually Supporting Ambush", page 88, paragraph c(8); "Employment of Armored Cavalry Platoon", page 89, paragraph c(9); and the "Use of APC's as a Direction Reference", page 90, paragraph c(11). These items have been extracted for possible inclusion in the next issue of Tips for Commanders.

h. (C) Reference item concerning "Duffle Bag Program", page 90, paragraph 2c(12): concur. Rapid reaction is of paramount importance if the enemy is to be eliminated after being located. Collocation of monitoring teams on the same fire support base that has coverage over a string reduces the time required to transmit fire missions. Precomputed firing data will further reduce reaction time. Item has been extracted for consideration for inclusion in the next issue of the USARV Combat Intelligence Lessons. No action by DA or USARPAC is recommended.

i. (U) Reference item concerning "Night Approaches to Areas with Minimal Lighting", page 99, paragraph 21(5): concur. However, the aviator's decision as to whether a tactical, normal, or steep approach will be used, day or night, depends upon the tactical situation, mission requirements, approach path obstructions, and the area of intended landing. There are standardized approach procedures, and these are applicable to both day and night operations. These procedures are outlined in USARV standardization maneuver guides, which are issued to all instructor pilots. Night approaches are standardized; the execution of a particular kind of approach, or the modifications thereto, depends upon the requirements of the prevailing situation, consistent with the safety of the aircraft crew and passengers.

j. (U) Reference item concerning "Wearing of Fire Retardant, Nomex Flight Clothing", page 100, paragraph 21(6): concur. Nomex flight clothing is the approved fire retardant clothing for Army aircraft crewmembers. AR 95-1 and USARV supplement to AR 95-1 states that fire retardant clothing will be worn by aircraft crewmembers. The recommendation also states that a central issue facility for flight clothing and equipment should be established. The 25th Infantry Division is in the process of establishing such a facility; other divisional units either have or are establishing a central issue facility for flight clothing and equipment. The above information was passed to the Aviation Safety Officer, 25th Infantry Division.

CONFIDENTIAL

AVHGC-DST (1 Feb 70) 2d Ind
SUBJECT: Operational Report - Lessons Learned, 25th Infantry Division,
Period Ending 31 January 1970, RCS CSFOR-65 (R2)

k. (U) Reference item concerning "Peneprime Distributor Availability", page 100, paragraph 1(8): concur. A number of expedient peneprime rigs are described in USAECAV Engineering Bulletin 415-4, "Expedient Peneprime Distribution", dated 25 February 1969. Distribution of the bulletin included Division Engineer, 25th Infantry Division.

l. (U) Reference item, Inclosure 7, subject: The MDH-5 Minature Directional Mine (U). Inclosure has been extracted for consideration for inclusion in the next issue of the USARV Combat Intelligence Lessons.

FOR THE COMMANDER:

L. D. MURRAY
CPT, AGC
Assistant Adjutant General

Cy furn:
II FFORCEV
25th Inf Div

CONFIDENTIAL

GPOP-DT (1 Feb 70) 3d Ind (U)
SUBJECT: Operational Report of HQ, 25th Infantry Division for Period
Ending 31 January 1970, RCS CSFOR-65 (R2)

HQ, US Army, Pacific, APO San Francisco 96558 13 APR 1970

TO: Assistant Chief of Staff for Force Development, Department of the
Army, Washington, D. C. 20310

This headquarters concurs in subject report as indorsed.

FOR THE COMMANDER IN CHIEF:



L.M. OZAKI
CPT, AGO
Asst AG

CONFIDENTIAL

CONFIDENTIAL

TROOP LIST 25TH INFANTRY DIVISION

AS OF 31 JANUARY 70

I. ORGANIC

- a. **Command & Control Elements**
 - HHC, 25th Inf Div
 - HHC, 1st Brigade
 - HHC, 2nd Brigade
 - HHC, 3rd Brigade
- b. **Combat Elements**
 - 3rd Sqdn, 4th Cav
- c. **Combat Support Elements**
 - HHE, 25th Inf Div Arty
 - 1st Bn, 8th Arty
 - 7th Bn, 11th Arty
 - 3rd Bn, 13th Arty
 - 2nd Bn, 77th Arty
 - 25th MP Company
 - 25th Aviation Battalion
 - 65th Engineer Battalion
 - 125th Signal Battalion
- d. **Combat Service Support Elements**
 - HHC & Band, 25th Div Spt Cnd
 - 25th Admin Company
 - 25th Med Battalion
 - 25th S&T Battalion
 - 725th Maint Battalion

II. ASSIGNED

AUTHORITY

- a. **Command & Control Elements - None**
 - b. **Combat Elements**
 - 1st Bn, 5th Inf (Mech)
 - 4th Bn, 9th Inf
 - 2nd Bn, 12th Inf
 - 2nd Bn, 14th Inf
 - 2nd Bn, 22nd Inf (Mech)
 - 3rd Bn, 22nd Inf
 - 4th Bn, 23rd Inf (Mech)
 - 1st Bn, 27th Inf
 - 2nd Bn, 27th Inf
 - 2nd Bn, 34th Armor (-)
 - B Co attached to 1st Inf Div
 - C Co attached to 1/5th Div (M)
 - F Co, 75th Inf (Ranger)
- | | |
|---------------|-----------|
| USARV GO 5063 | 3 Oct 67 |
| USARV GO 3502 | 15 Sep 69 |
| USARV GO 1836 | 21 May 69 |
| USARV GO 557 | 17 Feb 69 |

Incl 1

CONFIDENTIAL

///

CONFIDENTIAL

II. ASSIGNED (Cont)

AUTHORITY

c. Combat Support Elements	
9th Chemical Det	USARV GO 503 4 Feb 68
38th Inf Plt (Scout Dog)	" " 5423 24 Oct 67
44th Inf Plt (Scout Dog)	" " 4081 10 Aug 67
46th Inf Plt (Scout Dog)	" " 5425 15 Oct 67
66th Inf Plt (Combat Tracker)	" " 821 21 Feb 68
265th FA Arty Det (Radar)	" " 1412 22 Apr 69
d. Combat Service Support Elements	
15th Public Information Det	USARV GO 503 4 Feb 68
18th Military History Det	" " " "
20th Public Information Det	" " " "
25th Military Intelligence Company	" " " "

III. ATTACHED

a. Command & Control Elements - None	
b. Combat Elements - None	
c. Combat Support Elements	
B Btry, 5th Bn, 2nd Arty	
I Btry, 29th Arty (1 Plt)	
44th EOD Det	USARV GO 1357 10 Apr 67
159th Med Det, Helicopter Ambulance	" " 5121 4 Nov 68
258th FA Det (Radar-CM)	" " 4263 10 Sep 68
341st Avn Det	" " 931 16 Mar 69
362nd Avn Det	" " 1268 11 Apr 69
d. Combat Service Support Elements	
5th Weather Sqdn Det (USAF)	USARV GO 1122 1 Apr 69
3 AA Plt 2nd Civil Affairs Co	IIPFV GO 246 23 Mar 68
20th Preventive Med Det	USARV GO 4701 9 Oct 68
40th MED Det	" " 5166 9 Oct 67
390th Quartermaster Det (Petroleum)	" " 5406 23 Oct 67
USA Special Security Det	" " 4182 3 Sep 68
372 Radio Research Co	" " 2433 6 Jul 69

IV. OPERATIONAL CONTROL

3rd Brigade, 9th Infantry Division

CONFIDENTIAL

CONFIDENTIAL

V. DIRECT SUPPORT

4th Med Det	Cu Chi, RVN
B Co, 36th Signal Battalion	Cu Chi, RVN
53rd Signal Det	Cu Chi, RVN
61st Trans Det	Cu Chi, RVN
86th Hq Co Sig Bn Support	Cu Chi, RVN
94th Co Maint Support	Cu Chi, RVN
116th Assault Support Helicopter Co	Cu Chi, RVN
242nd Assault Support Helicopter Co	Cu Chi, RVN
277th Bn Resupply Service	Cu Chi, RVN
283rd Sig Det	Cu Chi, RVN
325th Weather Det	Cu Chi, RVN
501st Land Clearing Co	Cu Chi, RVN
578th Sig Co Support	Tay Ninh, RVN
587th Sig Co Support	Tay Ninh, RVN

LOCATION

VI. GENERAL SUPPORT

8th Aerial Port Sqdn	Cu Chi, RVN
12th Med Hospital Evac	Cu Chi, RVN
Hq & A Btry, 6th Bn, 15th Arty	Tay Ninh, RVN
20th TC Co Aircraft	Cu Chi, RVN
45th Surg MA (MUST)	Tay Ninh, RVN
269th Avn Bn Assault Helicopter	Cu Chi, RVN
362nd Engr Co	Tay Ninh, RVN
515th Engr Plt Asphalt Construction	Cu Chi, RVN
554th Engr Bn Construction	Cu Chi, RVN
588th Engr Bn Combat, C Co	Tay Ninh, RVN

LOCATION

CONFIDENTIAL

CONFIDENTIAL

DEPARTMENT OF THE ARMY
Headquarters 25th Infantry Division
APO San Francisco 96225

AVDCOP

12 November 1969

SUBJECT: Commander's Combat Note -- Sniper Operations

SEE DISTRIBUTION

1. I had a sniper performance report made to cover the period 26 Jul 69 through 20 Oct 69. I discovered that several battalions were doing quite well while others were not doing well at all. As I pointed out on my Commander's Combat Note -- Sniper Techniques, dated 7 Oct 69, I want to see all battalion commanders intensively managing their snipers. When I look at the sniper performance report, which I have attached as inclosure 1, I still do not get the feeling that each battalion commander in this division is personally supervising, on a centralized basis, the sniper assets that he has. If some in the attached list are centrally supervising, then they had better look at their practices because they are unproductive.
2. I charge each battalion commander to study the attached report and if you are not doing well, "Get on the ball and join the team." To those battalion commanders who are getting good results, keep it up -- good work.
3. I believe that our growing sniper capability will continue to demonstrate its significant worth. Look at all possible ways to employ snipers, both day and night. The methods of employing snipers are varied. The use of different techniques will prevent the establishing of easily detectable patterns and greatly enhance the sniper effectiveness. We cannot afford to let this program sag.
4. Brigade commanders energize this program.

1 Incl

s/ Harris W. Hollis
t/ HARRIS W. HOLLIS
Major General, USA
Commanding

DISTRIBUTION:

1 ea Bn; plus
25 - G3
3 - 1st Bde
3 - 2d Bde
3 - 3d Bde
3 - 3d Bde, 9th Inf Div
5 - C/S

Incl 2

REGRADE FOUO WHEN SEPARATED
FROM CLASSIFIED INCLOSURES

CONFIDENTIAL

114

A TRUE COPY:

Ralph J. Ballway
RALPH J. BALLWAY
MAJ, INF
Division Historian

SNIPER EFFICIENCY

	26 Jul - 31 Aug		1 Sep - 30 Sep		1 Oct - 31 Oct		Total For Period	
	No. Trained Snipers	No. Trained Snipers	No. Trained Snipers	No. Trained Snipers	No. Trained Snipers	No. Trained Snipers	No. Kills	No. Trained Snipers
1st Bde	3	4	1	8	8	15	12	15
4-9 Inf	0	0	0	0	2	4	2	4
3-22 Inf	0	2	0	3	4	4	4	4
4-23 Inf (M)	3	2	1	2	0	2	4	2
2-22 Inf (M)	0	0	0	3	2	4	2	4
2-34 Armor	0	0	0	0	0	1	0	1
2d Bde	14	5	13	6	22	12	49	12
2-12 Inf	2	1	6	2	5	3	13	3
2-14 Inf	8	3	1	3	9	4	18	4
1-5 Inf (M)	4	1	6	1	2	2	12	2
3-4 Cav	-	-	-	-	6	3	6	3
3d Bde	0	1	2	5	1	6	3	6
1-27 Inf	0	1	2	3	1	4	3	4
2-27	0	0	0	2	0	2	0	2
3d Bde 9th Inf Div	2	21	4	35	34	25	40	25
2-60 Inf	0	9	0	9	8	5	8	5
5-60 Inf	0	6	1	7	12	5	13	5
6-31 Inf	-	-	0	7	0	5	0	5
2-47 Inf (M)	0	3	3	7	9	5	12	5
Co E 75th Inf	2	3	0	5	5	5	7	5
Other	2	13	2	12	4	12	8	12
3-4 Cav	0	2	0	2	-	-	-	-
Co F 75th Inf	0	0	0	0	0	1	0	1
Cadre	2	11	2	10	4	11	8	11
Division Total	18	44	27	66	67	70	112	70

DOWNGRADED AT 3 YEAR INTERVALS;
 DECLASSIFIED AFTER 12 YEARS.
 DOD DIR 5200.10

Incl 1 to Incl 2

FOR OFFICIAL USE ONLY

DEPARTMENT OF THE ARMY
Headquarters 25th Infantry Division
APO San Francisco 96225

AVDCCS

7 January 1970

SUBJECT: Commander's Combat Note --Employment of CS to Capture POW's

SEE DISTRIBUTION

1. One of the best sources of intelligence is a live enemy soldier. In conducting operations we should seek the enemy out, fix him and if necessary eliminate him. We must keep in mind, however, that if he can be persuaded to Chieu Hoi or can be captured he may be a valuable source of intelligence.
2. The riot control agent CS can be employed as a non-persistent chemical agent in tactical situations to force the enemy from cover and concealment and facilitate his capture. The M7A3 CS hand grenade can be used effectively to flush enemy personnel from spider holes, tunnel complexes and bunkers.
3. I realize that the use of CS is not a new technique to some of you, but I think it is worthy of mention. I desire commanders at all levels to insure that CS grenades are available with ground troops on operations and be mindful of the value of a captured enemy.

s/ Harris W. Hollis
t/ HARRIS W. HOLLIS
Major General, USA
Commanding

DISTRIBUTION:

A; plus
25 - G3
30 - 1st Bde
30 - 2d Bde
30 - 3d Bde
75 - 3d Bde 9th Inf Div

A TRUE COPY:

Removal of protective markings 'FOR
OFFICIAL USE ONLY' cannot be prede-
termined.

RALPH J. BALLWAY
MAJ, INF
Division Historian

Incl 3

116
FOR OFFICIAL USE ONLY

DEPARTMENT OF THE ARMY
Headquarters 25th Infantry Division
APO San Francisco 96225

AVDCCG

1 December 1969

SUBJECT: Observations of a Mechanized Company Commander

Brigade and Battalion Commanders, 25th Infantry Division, and
3d Brigade, 9th Infantry Division

1. I have observed our mechanized operations for a couple of months now and I think we are spending too much time riding and moving without gaining contact. At the inclosure are some observations of a former commander of a mechanized infantry company. He has set forth a number of very useful hints and observations, and I ask that appropriate commanders study the inclosure and make use of its items.
2. I am providing additional copies in the event you wish to distribute this to your company commanders.

1 Incl
as

s/ Harris W. Hollis
t/ HARRIS W. HOLLIS
Major General, USA
Commanding

DISTR:
Bde Cdtrs - 10 cys
Bn Cdtrs - 10 cys

A TRUE COPY:

RALPH J. BALLWAY
MAJ, INF
Division Historian

Incl 4

117

Observations of a Mechanized Company Commander

Generally speaking, mechanized forces can not be used efficiently when looking for small groups of enemy forces. At present, we are confronted with a situation in the 25th Infantry Division TAOI in which the enemy is severely fragmented. He is spread out over a large area and most often evades contact. He is living in well-concealed bunkers and tunnels, most of which are constructed with well-concealed trap doors and which are located in the most densely vegetated areas. He has been told to avoid contact with all American units, particularly with mechanized forces, for he has learned long ago that he is no match for the 50 caliber machinegun and the tremendous sustaining power of a mechanized force in a firefight. Instead he chooses to counter mechanized forces almost exclusively with anti-tank mines. He can hear mechanized units moving into his area and he has plenty of time to hide. Only when he is cornered and discovered will he fight.

The typical mech operation in which the mechanized forces move around in a mobile role with the troops riding on top of the APC is a waste of men and resources. Even when mech troops dismount they do not stray far from their good friend, the APC, for the average mech troop has disdain for walking and carrying heavy loads. He regards the APC as his home away from home, for it carries his food, ammunition and water, as well as his communications, and one must not forget the habitual container of cold soda. He has a good deal and he knows it, and only the most aggressive and competent leader can persuade him to leave his carrier behind.

We have reached a period where the chance meeting engagement with an enemy force is a rarity. Only the most careful planning, coupled with imaginative and well executed tactics will contribute to finding the enemy.

The following techniques are deemed useful:

The Ambush. The ambush is presently our best weapon against a fragmented enemy. A well-executed ambush takes the night away from the enemy and, properly executed, is the most efficient and least expensive way to wear him down in our TAOI. However, only the most careful attention to ambush techniques will produce results.

A good ambush starts in the FSB. First, and perhaps of the greatest importance, is the intelligence collection process through which an ambush location is selected. The average troop, if he knows he is going out to an area on an all-night ambush in which he is likely to encounter the enemy, will perform admirably in his ambush role. But if he knows he is only fulfilling a requirement to have X-number of ambushes in a particular unit each night and that he is going to an area which he feels will not be productive, his morale will be low, his efficiency also low, and the ambush patrol will be virtually doomed to failure before it starts.

Incl 1 to Incl 4

Careful consideration by the battalion commander, the battalion S-2, the S-3, the company commander, the platoon leader and the patrol leader concerned with the ambush patrol as to where and how the ambush will be employed is critical if success is to be gained. Once a likely ambush site is selected, the force concerned in the ambush must be thoroughly briefed, rehearsed, and equipped to accomplish its mission.

The selection of the patrol leader is a critical step in the ambush sequence. A good patrol leader who has the confidence of his men, who knows how to properly conduct an ambush, and who is given enough time to prepare his men and himself properly, will stand a very good chance of conducting a successful ambush. Moreover, the selection of the men who will make up the AP is very important.

Many units use a roster system in which different men are thrown together each night to make up an AP.

New leaders, new men, make for lots of confusion and poor efficiency in execution. Where possible, the same patrol leader and the same hand-picked men, employed together as a team, night after night, will pay dividends in the long run. They will learn to work together, have confidence in each other's abilities, and won't be afraid to pop the bush when the time is right.

Where possible, an officer or NCO who is Ranger qualified should be used as the patrol leader. As these resources are obviously scarce, the next most qualified people to lead patrols should be used.

Care should be taken to provide the patrol leader, once he has been given his mission, ample opportunity to rehearse his patrol during daylight hours in techniques of moving to an ambush location, setting up the ambush location--to include such items as who carries the Claymores, who sets them up, who fires first--how to search an area after the ambush has been popped and in what order to move to and from an area.

Obviously, there are a hundred more little details that each man must know if he is to have confidence in what he is doing, for only when a man knows what he is doing will he operate efficiently at night. When possible, a patrol should be given the opportunity to rehearse at night. Some techniques, such as setting up an ambush at the designated ambush site, quickly and silently; hasty ambush techniques to counter an unexpected enemy force while on the move; and silent arm and hand signals, could be practiced within the confines of the FSB. It doesn't take a great deal of time to go first class and do it right.

Care must also be taken to insure that those men who have participated in a night ambush have ample opportunity to rest during daylight hours. This rule

must be enforced by all commanders. Here again, utilizing the same men for night ambush missions will pay big dividends, for they will soon adjust to working during the night and sleeping during the day. In addition, the time required for day and night rehearsal can be cut down considerably when the same group of men are utilized under a particular patrol leader.

Stay-Behind Patrols. The enemy has for some time been employing the technique of following our forces when they move through certain areas. The stay-behind patrol employed with mechanized forces is a tremendously effective weapon available to any commander who employs it properly. The forces concerned should be briefed, rehearsed and organized along the lines of the paragraph above concerning ambush techniques.

As a mechanized force is moving through an area, and when the force commander spots a likely location to put a stay-behind ambush, a coded signal could be passed to the patrol leader. Quickly and silently the patrol could slip off the moving tracks and conceal themselves in a hasty ambush configuration. No one should move or talk during this critical insertion period. The men should be well concealed and remain alert in their hasty ambush configuration until darkness falls. At that time the patrol leader, who has been making a visual reconnaissance of the area, can move his patrol silently into the desired ambush configuration using arm and hand signals.

All radio traffic between the patrol and the controlling unit should be held to a minimum, and should only include a radio check and sitrep on a periodic basis.

The force commander who inserted the patrol together with his forward observer can plot the eight-digit location of the patrol for artillery and mortar coverage. By riding with the force commander, the patrol leader can receive verbally the exact location of his patrol before he is inserted, thereby minimizing the possibility of radio compromise of the patrol's location.

Reaction forces should be available somewhere within a brigade TAOI to quickly respond to a patrol if it needs help. In addition, the patrol should be properly equipped with such things as strobe lights, compasses and at least two radios, together with adequate Claymores, night observation devices, etc.

Stay-behind can also be used with air mobile forces. The key to the technique in either air mobile or mechanized insertion of stay-behind forces is first a clandestine insertion of the forces and, secondly, sufficient deception on the part of the departing force to make it appear that no forces were left behind. When using helicopters this can be easily done by making the stay-behind forces lie flat in the helicopter

during the initial insertion, with the other forces facing out either door. When extracting the same personnel should face out from either door to give an appearance of a full helicopter taking off. Once again, it is imperative that the stay-behind forces are well organized, briefed, and rehearsed prior to being utilized as a stay-behind force during an operation.

The stay-behind patrol is one of the best means of inserting a night ambush that we have. It minimizes the distance a patrol has to move at night into a designated ambush area and it gets the force there completely rested and ready to go to work. In addition, it makes ambush operations some distance from a FSB more feasible and therefore you incur a greater likelihood of achieving a contact with the enemy.

When To Pop the Bush. Where possible, snipers should be employed with the ambush patrol. Beyond 50 meters only the sniper should be used to engage an enemy force, unless the ambush personnel are well trained in night firing techniques.

A sniper using his silencer can be accurate beyond 300 meters at night when there is sufficient moonlight to activate his starlight scope. Generally speaking, if the patrol can see the enemy, a sniper can get some kills.

Employ artillery as a last resort. When a sniper engages a distant enemy the FO should get artillery cranked up in an on-call status. Only when the sniper feels he is no longer effective should artillery be called in. Remember, the enemy likes to retrieve his dead and wounded. It is very likely that after a sniper gets a kill, if the patrol waits patiently, more enemy will appear to drag off the body/bodies. Therefore the use of artillery only spooks the target.

When engaging enemy at a range of less than 50 meters the ambush should be triggered by the Claymore mines.

Patrols should avoid using automatic mode on their weapons, but instead well aimed shots in the semi-automatic mode should be utilized.

The coordination of patrols with electronic and airborne surveillance, to include radar, dufflebag and nighthawk should not be overlooked. Employ all the means available to you to help the patrol produce results.

CONFIDENTIAL

DEPARTMENT OF THE ARMY
Headquarters, 25th Infantry Division
APO San Francisco 96225

AVDCCG

9 January 1970

SUBJECT: Communist Sapper Attack (U)

SEE DISTRIBUTION

1. (C) On 19 November 1969 Communist Sapper Elements successfully attacked an ARVN artillery position at Tan Tru, Long An Province.
2. (C) The inclosure is the translation of the enemy's CPLAN and after action report of this operation. The documents were captured on 19 December via XSOA/C30 by Company D, 2d Battalion, 60th Infantry. Other documents captured at the same time identified the C3 Company, 211 Sapper Battalion, Sub Region 3.
3. (C) This document shows clearly the threat that a trained sapper unit poses to a unit whose commander fails to evaluate continually and improve his own security. Strength in numbers and multiple obstacles are not absolute deterrents to a trained sapper.
4. (U) I strongly recommend dissemination of the information in this document to at least the company commander level.

1 Incl
as

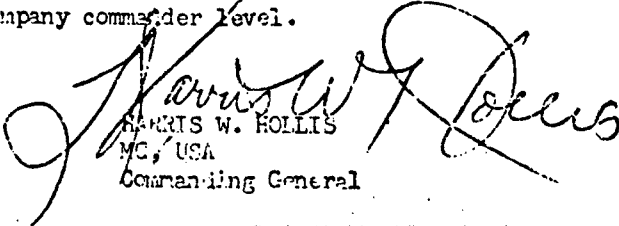
HARRIS W. HOLLIS
MG, USA
Commanding General

DISTRIBUTION:
B, plus G2 (20)

Best Available Copy

Incl 5

122
CONFIDENTIAL

DOWNGRADED AT 3 YEAR INTERVALS.
DECLASSIFIED AFTER 12 YEARS.
EOP 5200.10

CONFIDENTIAL

INTRODUCTION:

In the early morning hours of 19 November 1960, the 25th ARVN Division's Artillery Base Camp at Tan Tru (XS 667 630) came under sapper attack from an unknown number of enemy. During the ensuing battle 4 ARVN's were KIA, 12 WIA, two buildings destroyed and several weapons lost. The enemy lost three known KIA.

On 19 December 1960, D Company, 2nd Battalion 60th Infantry, 3rd Brigade, 9th Infantry Division engaged four enemy soldiers via XS 648 635 approximately 2 kilometers west of Tan Tru. Documents taken from one of the enemy KIA contained the attack plan, reconnaissance map and after action report for the 19 November attack on the artillery basecamp. Other documents captured from the individual identified his unit as the G3 Company, 211 VC Main Force Sapper Battalion, Sub Region 3.

Included in this report are translations of the VC attack plan, after action report, reconnaissance map and excerpts from the ARVN Duty Officers Log for the period of the attack. There is a time difference of approximately two hours between the VC attack plan and the ARVN Duty Officers Log for the beginning of the attack. It is not known if the attack was delayed for unknown reasons or the VC were using coded hours in their plans.

Translated by
Sfc Huynh Van Trung

Dennis L Roeding
DENNIS L ROEDING
CPT, MI
Interrogation Officer

Incl 1 to Incl 5

123
CONFIDENTIAL

**DOWNGRADED AT 3 YEAR INTERVALS;
DECLASSIFIED AFTER 12 YEARS.
DOD DIR 5200.10**

CONFIDENTIAL

I. ATTACK PLAN

Enemy Situation

This is an important target. The mission of the unit is to support the GVN Pacification Program, conduct sweep operations, and provide support to other ARVN units located in the area. The ARVN will try to hold this post since it provides support to other units and it would mean a political defeat, as well as military if this post is lost.

The base is located in a congested area. To the East is a HQ location, NE a Popular Forces post, SW an outpost and one base camp. A road runs from North to SW in front of the base.

The base is square shaped with live in bunkers in the four corners. There are two (2) troop and family living quarters, many bunkers, storage areas and foxholes. The HQ is located in the middle of the post.

Strength of ARVN forces: Sixty (60) men. Weapons include an unknown number of mortars, 1 x M1 and automatic rifles.

Obstacles: There are seven (7) rows of barbed wire with mines and trip flares. A trench is dug just outside the wall. On the inside is a one (1) meter high wall with eight tenths (0.8) meter high concertina.

Deployment and Operations of the ARVN: Sometimes at night there is one (1) platoon of PF's patrolling to the West and SW. They often use illumination rounds. *Strong Point: The main firing and defensive positions are West and SW. The strong points are the bunkers in each corner of the base.

Situation and Terrain Features: The area is low land with a river, canals, rice fields and high grass. An abandoned house and graves are located about 500 meters from the post.

Enemy Reinforcements: The surrounding outposts in the area have the capability to reinforce with Infantry firepower. The capability of the Infantry is weak.

Special Points of the Post: The ARVN in the post are very susceptible to a ground attack because we have never used Infantry tactics against them. The post depends heavily on reinforcements and security from other outposts in the area. They are afraid of our mortar attacks. There are not many combat troops in the post. They depend mostly on the four bunkers at each corner and reinforcements from other outposts.

124
CONFIDENTIAL

DOWNGRADED AT 3 YEAR INTERVALS;
DECLASSIFIED AFTER 12 YEARS.
DOD DIR 5200.10

CONFIDENTIAL

Our (V.C.) Situation: We must be prepared to attack the base upon orders from higher H.Q.

The Unit: Soldiers are new and have never participated in deep thrust fighting, therefore we must do the following:

1st Step: Conduct a meeting of Party Chapter members to review the weak and strong points of our unit, also familiarize the chapter members with the target that is to be destroyed. The unit must use its spare time in the next two nights for training in deep thrust tactics.

2nd Step: Make propaganda using the theme that the ARVN's killed many of their friends; make them hate the GVN.

3rd Step: The soldiers are new, so we may not be able to use raid and penetration tactics.

Preliminary Plan: In order to completely destroy this location with the least casualties on our side, we must use surprise raid tactics with small size forces to penetrate deeply and split the enemy forces.

Organization of our Forces:

1. Personnel: We will organize two elements designated "A" element and "B" element. A element will be composed of four cells and B element three cells. The total strength of the two elements will be 21 men.

2. Weapons: 6xBL0 with 30 rounds
1xDM10 directional mines
10x parachute grenades
100x hand grenades
?x AK 47 rifles

Mission: The post will be divided into two areas designated "A" and "B" (See Map #1). A area consists of two watchtowers, one troop billets, two bunkers, a storage area, three houses, and numerous foxholes.

Organization of A element: The four cells, totalling 12 men, will be equipped with 3 x BL0's, 5 x parachute grenades, and 1 x DM10 directional mine.

Mission of Each A Element Cell: 1st Cell: (See Map #2): At the start of the attack, use BL0 and parachute grenades to destroy the HQ and occupy the target. Then throw hand grenades into the foxholes and occupy the fourth bunker. From bunker number 4 fire BL0 into house number 5, occupy the house and be ready to reinforce the B element.

CONFIDENTIAL .

2nd Cell: (See Map #3): At the start of the attack, one man use grenades to destroy the combat fortification at the wall, while two other men move quickly to occupy the storage and "F Point" (Not shown on original map). Use B40 and fire into house number 2, then throw hand grenades into the foxholes, occupy house number 2, and be prepared to reinforce Cell #1 on order.

3rd Cell: (See Map #4): One man use grenades to destroy watch tower #3. The other 2 men use AK 47 and B40 to destroy watch tower number 4, use the B40 then to destroy house #2. Occupy watchtower #4 and protect the right flank. Be prepared to reinforce the 1st and 2nd cells.

4th Cell; (See Map #5): Use the DH 10 directional mine to destroy house #8. The other 2 men use AK 47 and grenades and occupy the other houses. Be prepared to reinforce the B element after occupying all houses. Use a flashlight to signal the completion of occupation.

CONFIDENTIAL

B AREA

B area has 3 watchtowers at the corners, one project house and location "E" (Not shown on original map). Use nine men divided into three cells with the following weapons: 3xM40, 50 Grenades and 3xAK-47s.

Mission of each cell:

1st Cell: (See map #6) 1xM40, 1xAK-47 and grenades. Use the M40 to destroy the watchtowers, 1 and 2. Occupy watchtower 2 and signal Cell 4 of A Element. Wait for further orders.

2nd Cell (See map #7): 1xM40, 1xAK-47 and grenades. Use the M40 to destroy Artillery gun position number 6 and occupy this location. From position number 6, use the M40 to destroy fortification number 5, return to position number 6 and be prepared to reinforce A element. Signal the 1st Cell of A Element and if they do not occupy house number 5, use your M40 to destroy the house. Then the 1st Cell of A Element must occupy that location. During the occupation of positions number 5 and 6, watch the left flank and use small arms to destroy any enemy that you see. Make contact with the 3rd Cell (B Element). If the 3rd cell has not completely occupied their positions, two men from the 2nd Cell must use AK and grenades to support the 3rd Cell. The M40 must stay at position number 6 and be prepared to fight the enemy if he appears at fortification number 5 on the left flank and house number 5 of A area.

3rd Cell: (See Map #8): Use two rounds of M40 to destroy house number 7 and occupy this location. Contact the 1st Cell and occupy "E" Area. Wait for further orders. *The command element must know the situation of the 1st and 2nd Cells of A Element and the 1st and 3rd Cells of B Element. The main mission is to occupy the four watchtowers, houses number 3 and 7.

Departure time

In the evening, send out one Recon Team to the first roll of barbed wire, report and stay there. The wire cutting team will then join the Recon Team and begin cutting the wire. The Road Recon Team will move to the ferry boat at 2000 hours and give their report. We will leave the departure line at 2000 hours. We must pass over two canals so be careful not to lose any weapons.

Movement Order

The 1st Cell, 2nd Cell, 3rd Cell and 4th Cell of A Element will move out first followed by the 1st, 2nd, and 3rd Cell of B Element. A Company cadre will be with each element to act as guide. Reach the rally point by 2200 Hours.

CONFIDENTIAL

Actions during Movement to the Target

If we receive artillery, keep moving toward the target. If we make contact with the enemy, the operation is cancelled. If the sampans sink while crossing the canals and we only lose 1/5 of our weapons, continue the operation.

Time for Movement into the Target Area

At 2330 hours "A" element begin movement to positions within the A area. Order of movement is the 1st, 2nd, 3rd, & 4th cell in order. At 2400 hours the B element begins movement to positions within the B area. At 2450 hours, all cells must be in position.

Actions during Movement into the Target Area

If the enemy discovers us during movement to positions within the target, do not open fire and withdraw completely. If one cell receives casualties from mines or tripflares, use the reserve team in the attack.

Time of Attack

At 0100 hours, the 1st Cell of A element will open fire with B40 at the target Headquarters. Use a flashlight to signal when the target is occupied. Reinforcements will be provided on order by the (VC) HQ element. Attack your own targets. Do not move to another target unless ordered to do so.

Clearing the Battlefield

We must first check on our WIA, KIA and weapon losses. NOTE: It is authorized to use captured weapons in the target area if we run out of ammo.

Capture all the enemy's booty. If captured weapons cannot be carried, use grenades to destroy them. Use B40 to destroy artillery guns and storage areas.

Release POWs at our usual place after giving them reeducation and propaganda. NFI

Withdraw

On order of withdraw, all personnel move out to the B area. In case the enemy sets up a blocking force in the B area, try to avoid contact. If they open fire, one cell will stay behind to cover for the others. Company cadre will inspect the men, weapons and ammo status at the rally point and report their findings to Company HQs. We must be ready to fight again the next day.

128

CONFIDENTIAL

II. VC AFTER ACTION REPORT

TROOP MOVEMENT

All cells passed through the barbed wire successfully. The 1st cell occupied watchtower number 2, and attacked enemy personnel in the foxholes. The 2nd cell received one casualty in their attempt to occupy the fortification. The 2nd cell occupied the house. The 4th cell burned and occupied house number 8.

Good Points of the Attack

Overall, our cadre showed good leadership and completely occupied the target.

Weak Points of the Attack (B element)

The 1st cell cadre sometimes lost command and soldiers sometimes missed when firing into targets. They did not exploit all their capabilities. Soldiers were not aggressive in fighting and did not completely follow their given mission.

The 2nd cell completely destroyed their given target, however, soldiers were not aggressive in fighting. The wounded soldier did not stay at his position which enabled the enemy to recapture the target. The cell did not signal with their flashlight for reinforcements.

The 3rd cell was aggressive and had high morale. They occupied their target but did not exploit all their capabilities.

Good Points of the "Arrow" Element

Good leadership, completely destroyed their target.

Weak Points

Leader did not report to the HQ element on time. They did not withdraw on order. They lost one weapon.

"A" Element

The 1st cell were good in occupying the given target and completed their mission.

The 4th cell was good in the beginning and occupied their given target but did not give the proper signal and almost fired into our own men.

CONFIDENTIAL

Overall Weak Points

We did not have a schedule to reinforce our troops because signalling with flashlights failed. We were too slow in the withdraw and our wounded soldier was not evacuated to the rally point.

III. ARVN ARTILLERY DUTY OFFICER'S LOG

The following is an excerpt of the ARVN Artillery Duty Officer's log for period 180000 to 190000 November 1969. The period covered by this translation is 190330 to 190610 which covers the attack against the ARVN Artillery Compound at Tan Tru (D), Long An (P).

- 0330 - Was notified by Tan An TOC that Tan Tru received fire and a building was burning.
- 0340 - Requested a flare ship and U.S. help to stop the fire.
- 0400 - Report from Tan Tru TOC that FDC is completely destroyed and the fire is still burning. Casualties at this time are 1 KIA, 5 seriously wounded and 6 slightly wounded, (including PF dependents).
- 0415 - Initial report from Tan Tru Artillery - 2 KIA (NCOs) and 2 WIAs (Officers).
- 0430 - Report from Tan Tru Artillery - Have 4 KIA at this time.
- 0450 - ARVN Artillery Bn HQs requests that Long An Sector clear Tan Tru Road as early as possible so they can move additional men to the area.
- 0452 - Report from 2A - Almost all individual weapons are lost or missing.
- 0455 - Report from 2A - All equipment has been damaged. The flare ship is still on station.
- 0500 - Report from 2A - We are still receiving enemy fire. U.S. personnel have stopped the fire.
- 0520 - Report from 2A - Artillery piece #6 was damaged by grenade. Friendly casualties: 4 KIA & 12 WIA.
- 0535 - From Tan Tru ARVN - Have 20 artillery personnel not wounded.
- 0550 - From Tan Tru ARVN - We still have 26 x M16, 1 x M79 and 1 x M60. Others are missing (no number specified). Following equipment was damaged: 1 x 3/4 ton truck - light, 1 x 105mm Howitzer - hole in tube from grenade, 1 x Radio (not specified) - completely destroyed in fire.

130

CONFIDENTIAL

CONFIDENTIAL

- 0555 - From Tan Tru ARVN - We have found three VC bodies: one body at perimeter bunker, one at gun #6 and one in perimeter wire.
- 0610 - From Tan Tru ARVN - Casualties of reaction force: 2 KIA, 2 WIA and 1 x M16 MIA.

CONFIDENTIAL

MAP #1

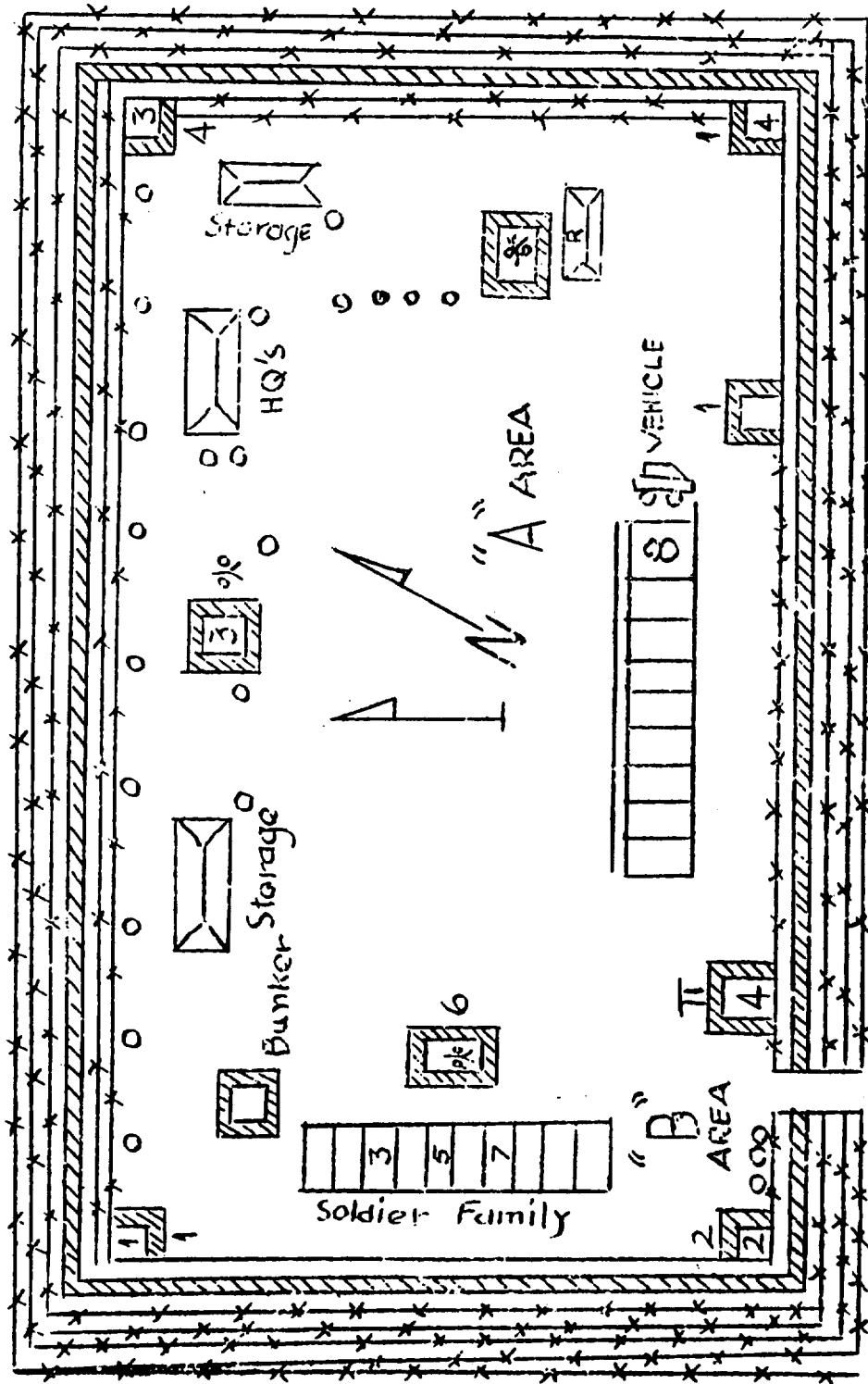

CONFIDENTIAL

MAP # 2

1. Use B40 and parachute grenades to destroy HQ and occupy.
2. Throw hand grenades into foxholes and occupy fourth bunker.
3. From bunker 4 fire B40 into house #5, occupy and prepare to reinforce the B element.

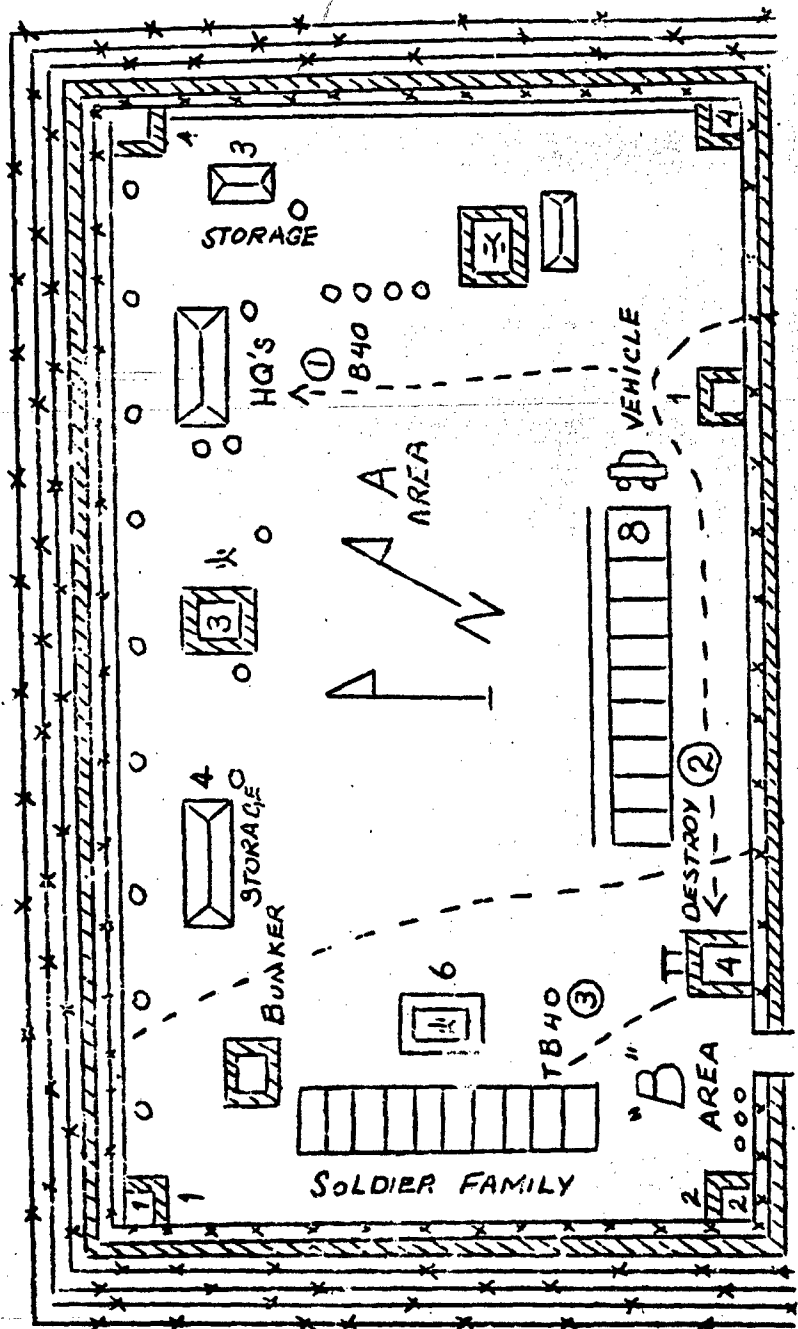

133
CONFIDENTIAL

MAP #3

1. One man use grenades to destroy combat fortification at wall, two others occupy storage and "A" point. (Not on original Map).
2. Use BJO fire on house #2, throw grenades in foxholes, occupy house 2 and prepare to reinforce Cell #1 on order.

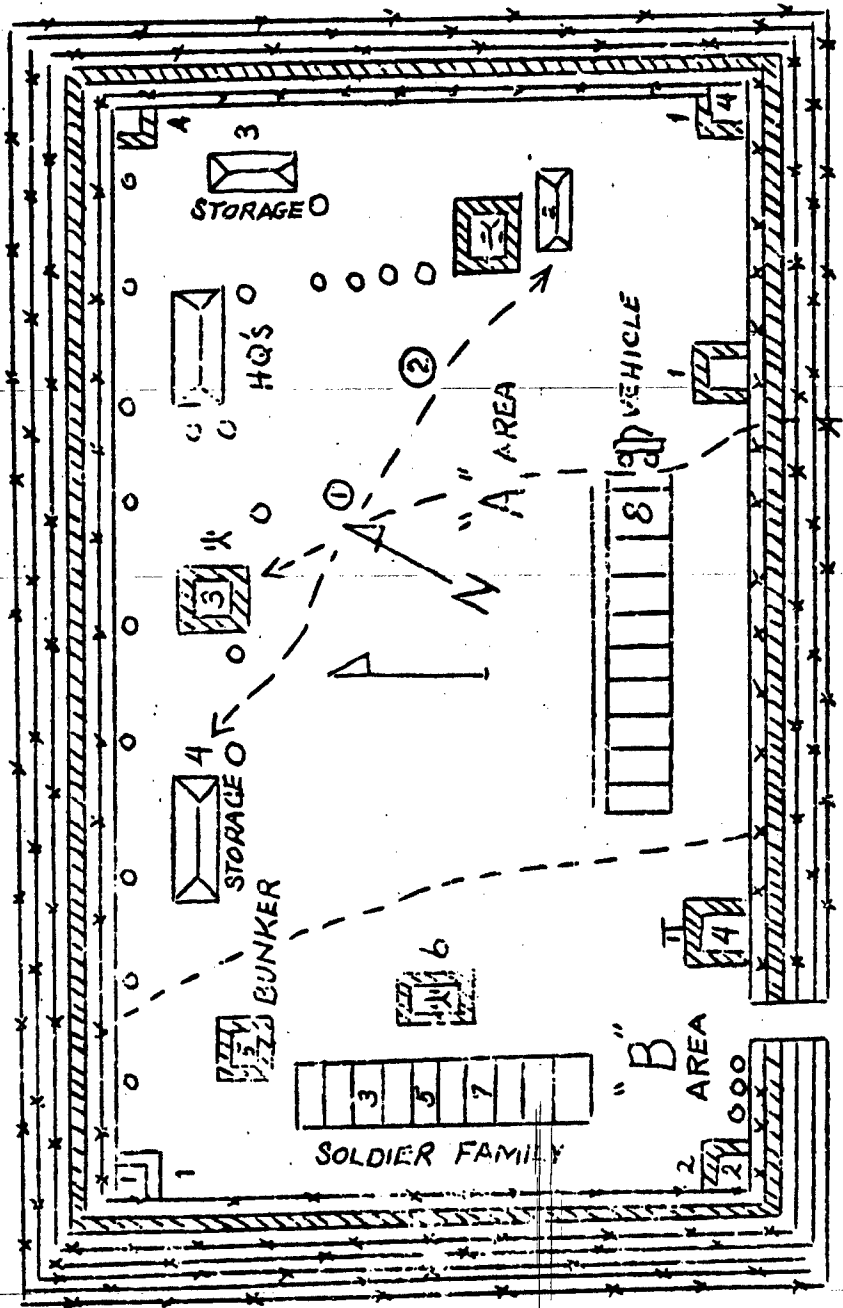

CONFIDENTIAL

MAP A

1. One man with grenade hit bunker 3.
2. Two men w/ B40 & AK hit bunker 4.
3. Then use B40 to destroy house #2.
4. Return & occupy bunker 4 and protect right flank.

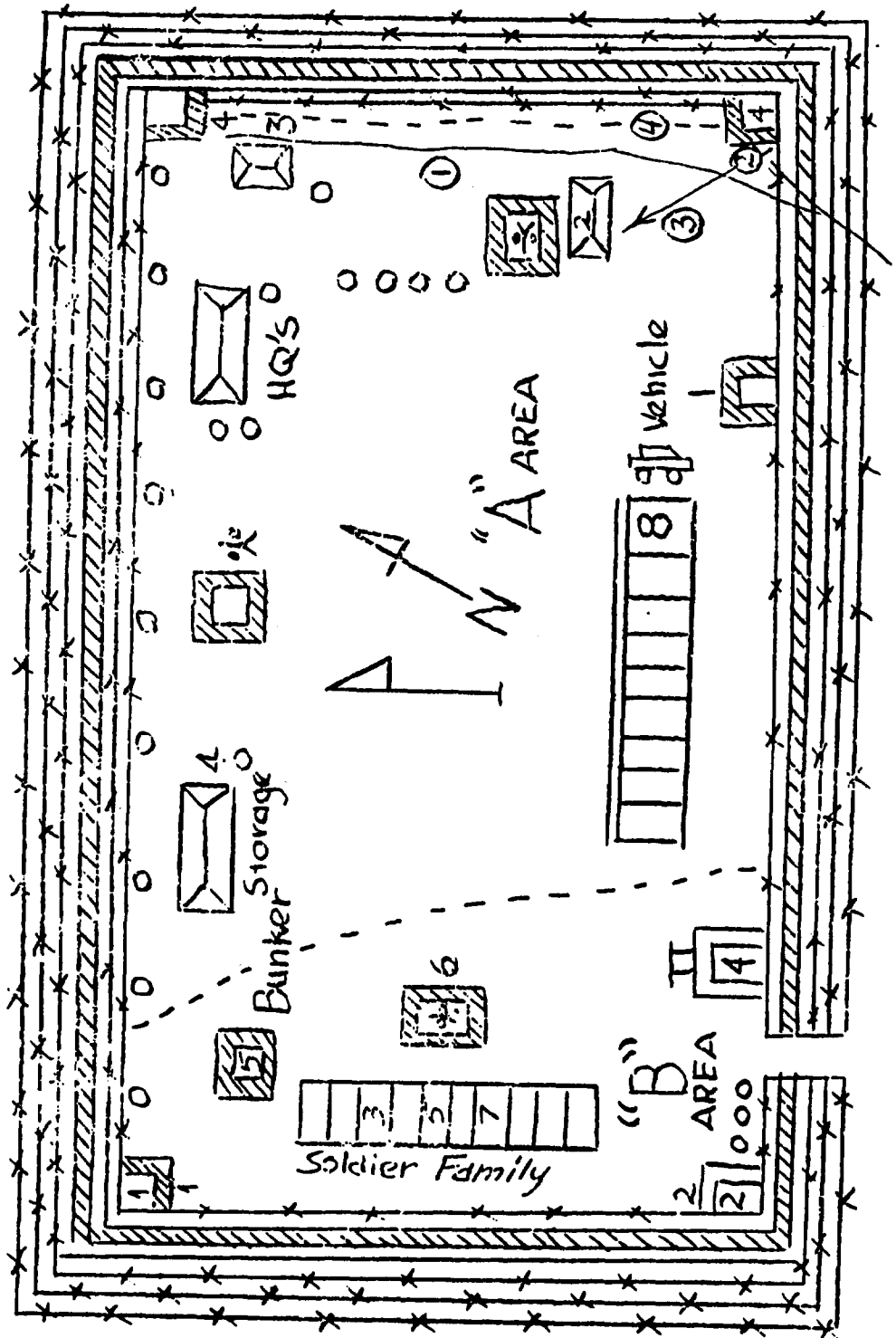

MAP #5

1. Use the DH 10 to destroy house #8. (Claymore)
2. Two others use AK 47's and grenades to occupy the other houses.

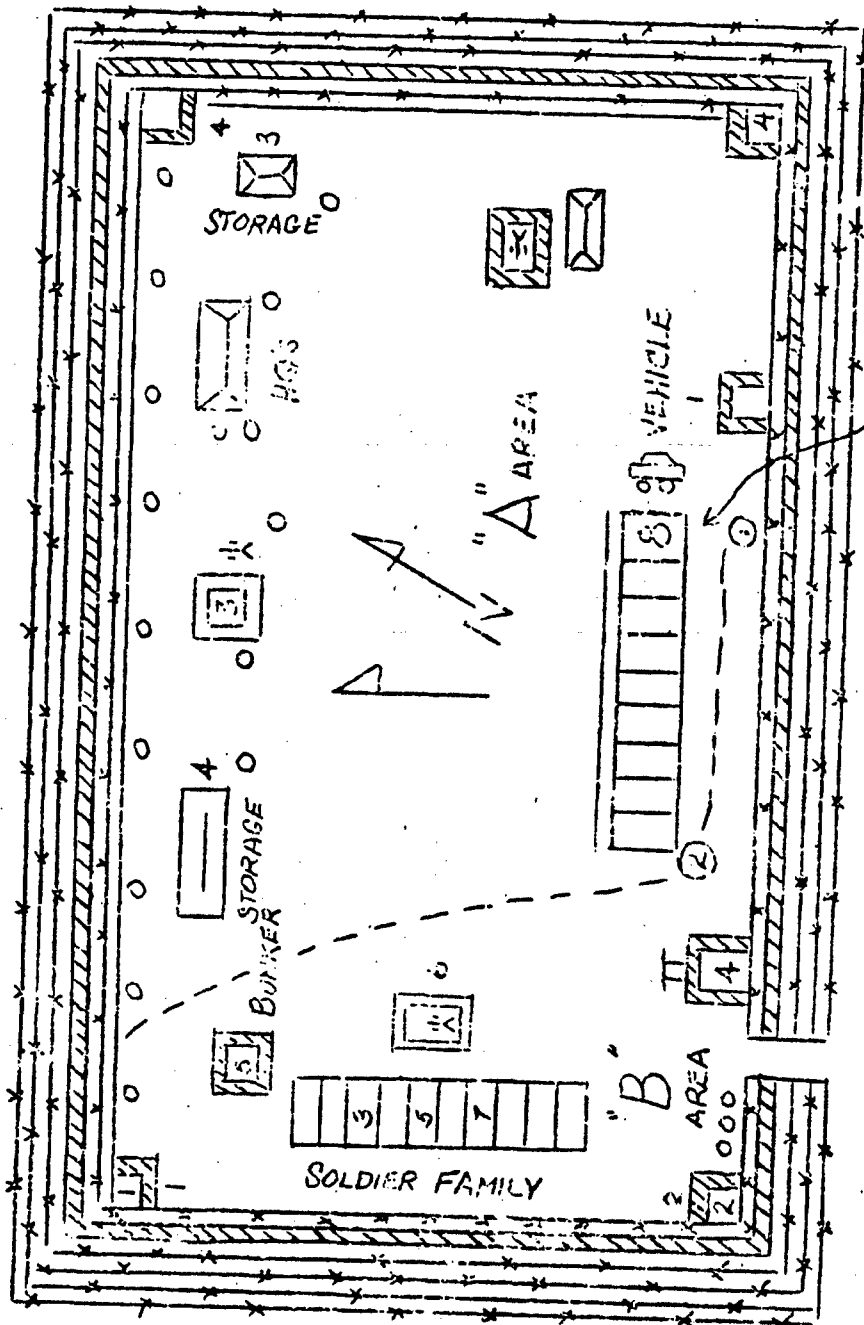

CONFIDENTIAL

MAP #6

1. & 2. Use B10 to destroy watchtowers 1 & 2.
3. Return and occupy watchtower 2.

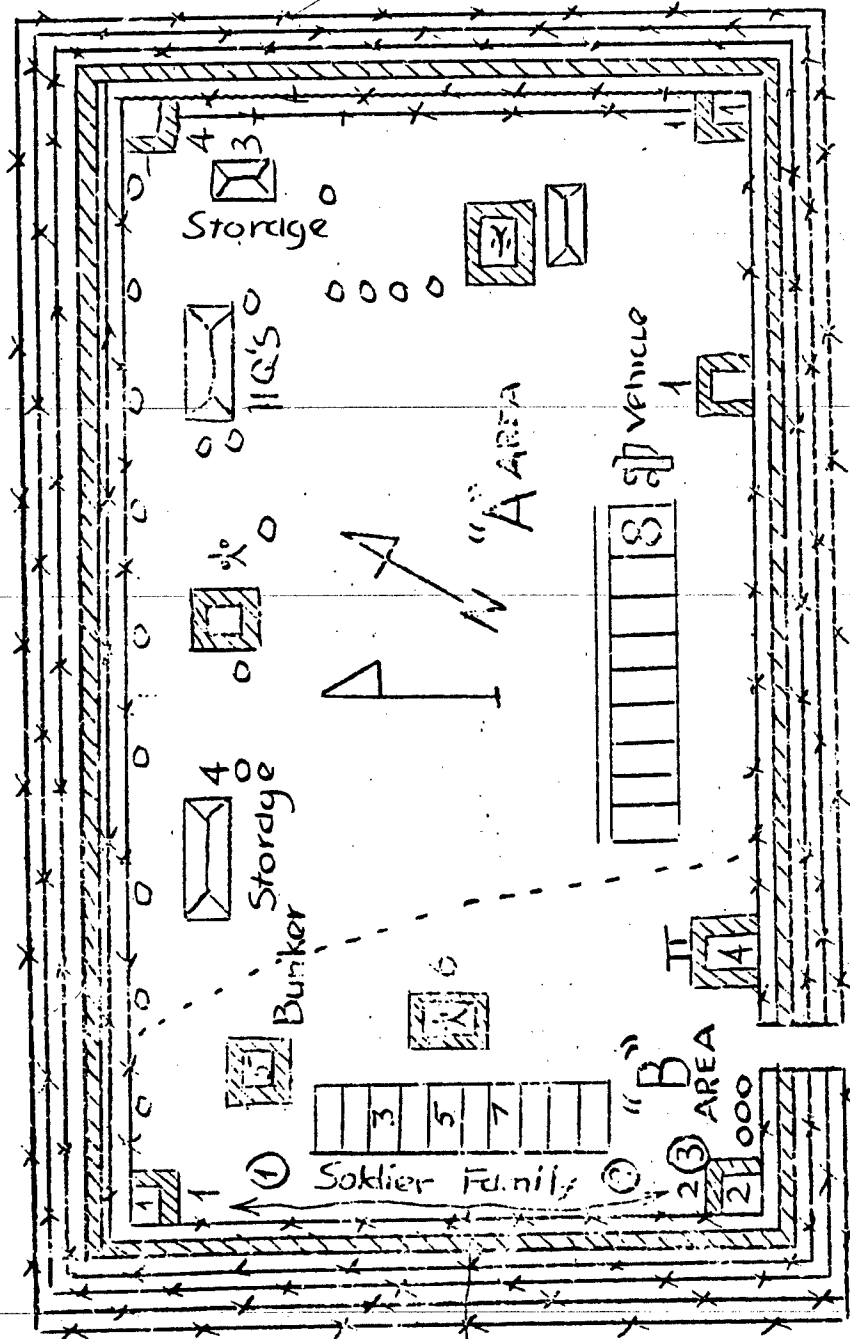

CONFIDENTIAL

MAP #7

1. Use E4C to destroy gun position 6.
2. From position 6, use E4D to destroy fortification number 5.
3. Return to position 6 and prepare to reinforce "A" element.

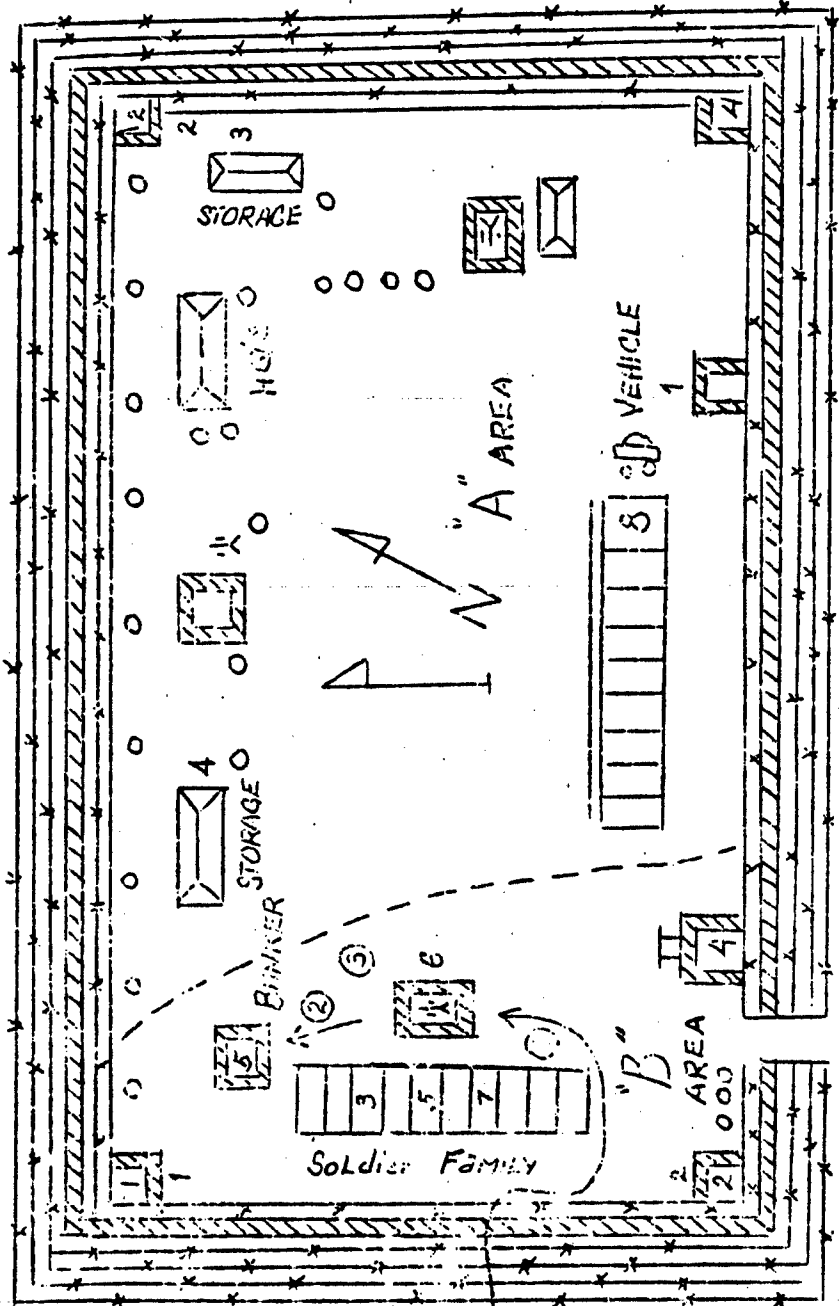

MAP # 8

- 1. Use two rounds of Pl40 to destroy house #7 and occupy.

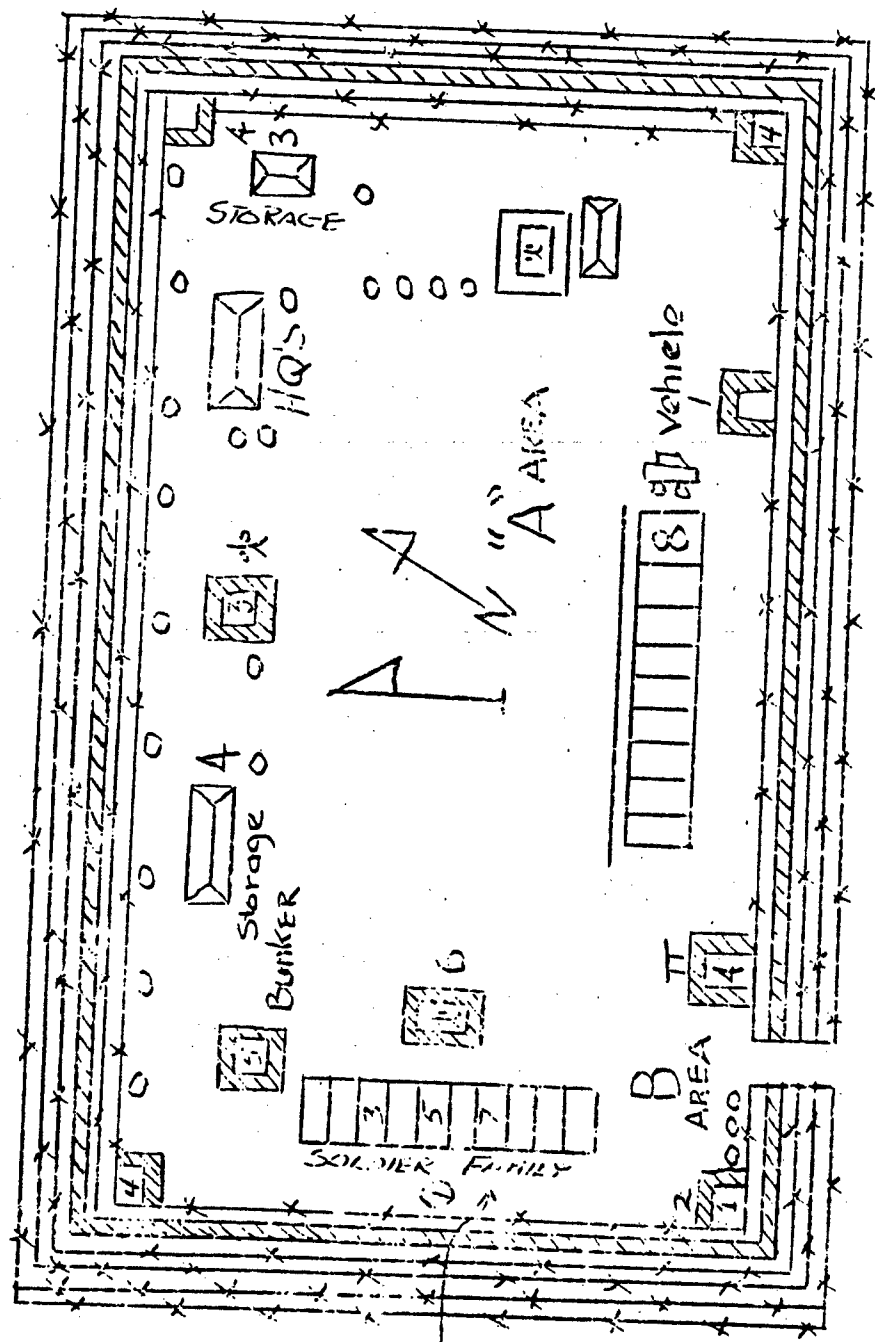

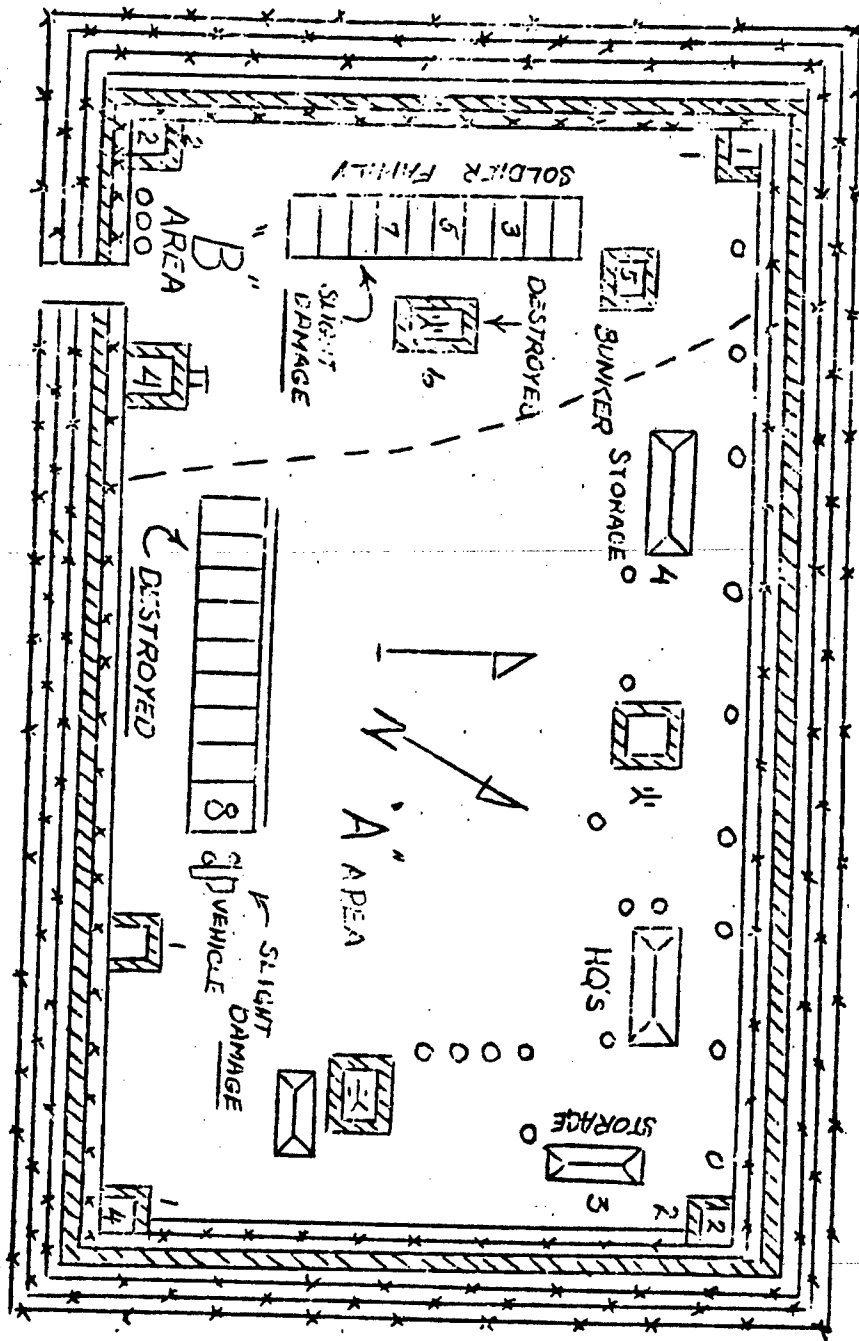

REPORTED DAMAGE

MAP #9

7

DEPARTMENT OF THE ARMY
Headquarters 25th Infantry Division
APO San Francisco 96225

AVDCCG

2 December 1969

SUBJECT: Treatment of Prisoners and Detainees

SEE DISTRIBUTION

1. The purpose of this letter is to point out the necessity for proper treatment of prisoners and detainees, and to describe standard procedures for their handling during evacuation.
2. Prisoners and detainees must be accorded humane treatment. They must not be roughed up, abused, or mistreated. To do so would be inhumane and in violation of current directives and international law. There are two other good reasons for treating prisoners and detainees properly. First, it furthers the accomplishment of our immediate combat mission. Experience indicates that properly treated prisoners have been very responsive to interrogation. Further, the word spreads quickly, and enemy troops learning that VC prisoners receive immediate medical attention, food, and water will have cause to doubt the truthfulness of communist propaganda. Thus, they in turn may be induced to surrender more easily. Each enemy soldier taken from the battlefield by voluntary surrender is one less we have to fight. More importantly, PW's are an important source of intelligence. Second, it contributes to the effectiveness of our overall pacification effort. Many detainees turn out to be innocent civilians and are returned to their homes which are often located in VC influenced areas. If these detainees have been afforded good treatment, they will represent to their neighbors tangible and realistic proof of our announced intentions and objectives in their country, and possibly create a more favorable atmosphere of cooperation. We can thus re-insert in VC influenced areas civilians who understand why we are here and who will influence other civilians toward an understanding of our aims.
3. It is recognized that humane treatment of prisoners frequently runs counter to the emotional atmosphere of capturing units, especially after engagements in which US casualties have occurred. It is also recognized that attached allied personnel, who may have suffered hardships at the hands of the enemy, may not be inclined to offer humane and kind treatment. Therefore, it is essential that every man in this division completely understand the necessity for proper treatment of prisoners and detainees, and that commanders at all levels give their personal attention to this matter and insure proper treatment.

Incl 6

141

2 December 1969

4. The following procedures will be emphasized:
 - a. Prisoners and detainees will be properly tagged with USARV Form 365.
 - b. As soon as possible after apprehension and at the lowest level, prisoners and detainees will be provided with the necessary medical aid, food, water.
 - c. Prisoners and detainees taken into custody by US units will remain in US evacuation channels.
 - d. At least one US officer will be present during initial interrogation by the apprehending unit. Under no circumstances will prisoners or detainees be left without US supervision. Prisoners and detainees will be evacuated as rapidly as the tactical situation permits.
5. Under international law we are responsible to insure that the provisions of the Geneva Conventions are carried out. Unlawful acts or omissions causing death or endangering the health of a prisoner of war are prohibited and are in violation of the provisions of the UCMJ.
6. The contents of this letter will be disseminated to all personnel and reiterated periodically for the benefit of newly assigned personnel.

s/ Harris W. Hollis
t/ HARRIS W. HOLLIS
Major General, USA
Commanding

DISTRIBUTION:
A

A TRUE COPY

Ralph J. Ballway
RALPH J. BALLWAY
MAJ, INF
Division Historian

CONFIDENTIAL

DEPARTMENT OF THE ARMY
Headquarters, 25th Infantry Division
APO San Francisco 96225

AVDCIN

13 January 1970

SUBJECT: The MDH-5 Miniature Fixed Directional Mine (U)

SEE DISTRIBUTION

1. (C) On 21 November 1969 U. S. forces operating in Quang Tri Province, I Corps Tactical Zone, captured three MDH-5 Miniature Fixed Directional Mines.
2. (C) These mines are miniature versions of the VC D-10 directional mines and our own Claymore. The small size (4" x 2") makes it an item which can be easily concealed on an individual's person. As such it is an ideal weapon for terrorists or the enemy's special action units.
3. (C) As yet, none of these have been discovered in III Corps. However, because of the threat posed by this weapon, all Commanders will insure all personnel in their commands are oriented on the comments at Inclosures 1 & 2.

FOR THE COMMANDER:

- 2 Incl
1. Extract from CDEC Report
6 031 0088 69
2. Diagram of MDH-5 Miniature
Fixed Directional Mine.

s/ Ivan S. Hutton, Jr. CW2
for t/ L. R. PARKHILL
1LT, AGC
Asst AG

DISTRIBUTION:
A

A TRUE COPY:

Ralph J. Ballway
RALPH J. BALLWAY
MAJ, USA
Division Historian

Incl 7

CONFIDENTIAL

DOWNGRADED AT 3 YEAR INTERVALS;
DECLASSIFIED AFTER 17 YEARS.
DOD DIR 5200.10

CONFIDENTIAL

Inclosure 1: MDH-5 Miniature Fixed Directional Mine (U)

1. (C) On 21 Nov 69 the 287 Ordnance EOD Team Of Phu Bai recovered three North Vietnamese manufactured MDH-5 Miniature Fixed Directional Mines in Quang Tri Province, I CTZ.

2. (U) Physical characteristics of the MDH-5 Miniature Fixed Directional Mine are as follows:

Type	Antipersonnel - fragmentation
Color	OD
Case Material	Thin sheet metal
Diameter	10.6 cm (4 $\frac{1}{4}$ inches)
Thickness	4.9 cm (2 inches)
Main Charge	TNT and RDX
Weight with stand	1.9 lbs
Fragments - Material	Pellets made from steel rod
Dimensions	5mm x 5mm
Quantity	482
Markings (On the concave face)	HAT NAY HUCNG VE FIA DICH
(Top)	Translation: Point this side toward enemy MDH-5 LO 3-67-F

3. (C) This circular shaped mine has a concave face which faces the target. A double row of steel pellets are imbedded in a matrix of resin. The fuze well is located in the center of the convex back. The two metal cleats beside the fuze well are used to wrap the electrical firing wires to insure the retention of a blasting cap in the fuze well. A steel rod, 5mm in diameter, forms the circular base at the stand. By means of a cantilever arm attached to the mine and the stand by two wing nuts the mine can be elevated to the desired angle and rotated 360 degrees. The circular base of the stand can be folded into the mine, making it easy to transport. The mine has no sighting device.

144

CONFIDENTIAL

Incl 1 to Incl 7

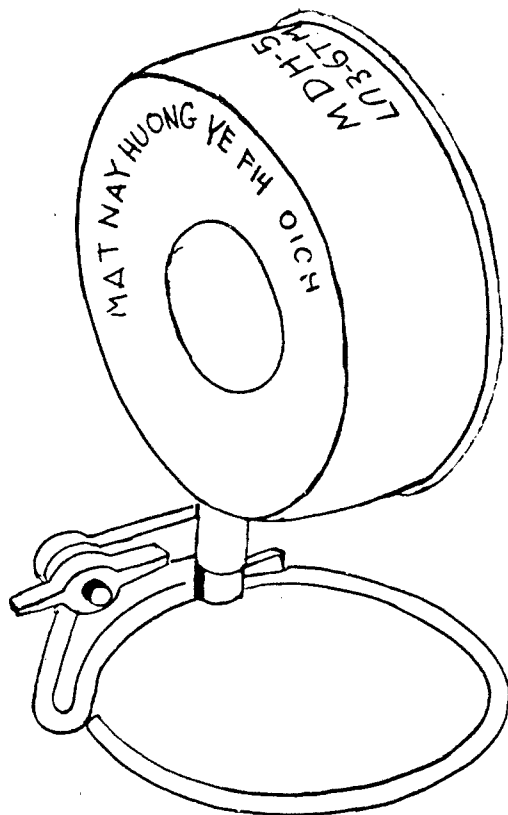

MDH-5
MINIATURE FIXED
DIRECTIONAL MINE
(Not Drawn To Scale)

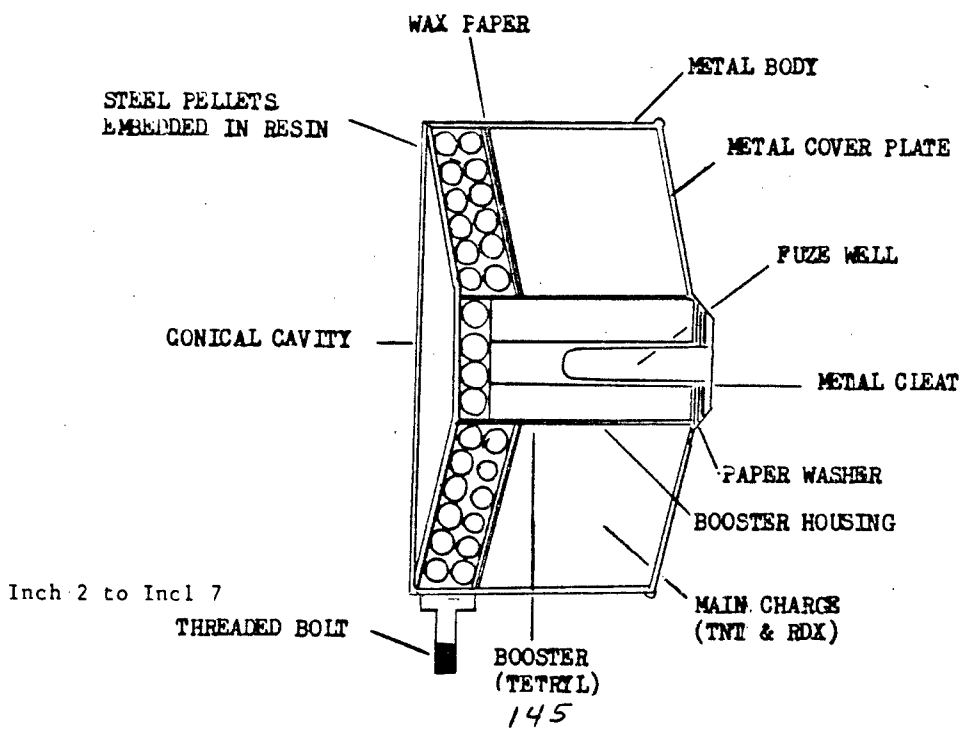

CONFIDENTIAL

DEPARTMENT OF THE ARMY
Headquarters 25th Infantry Division
APO San Francisco 96225

AVDCOP

25 November 1969

SUBJECT: Air Cavalry Package (Mini-Cav) (U)

SEE DISTRIBUTION

1. (U) PURPOSE. To establish concept and provide guidance for the brigade employment of the Air Cavalry Package, hereafter called "Mini-Cav".
2. (U) MISSIONS. The mission of the Mini-Cav is to find, develop and exploit intelligence targets and provide a quick reaction capability within the 25th Infantry Division's Tactical Area of Interest.
3. (C) ORGANIZATION. a. The Mini-Cav Force is organized under two separate configurations within this Division.

(1) Organic Mini-Cav. The basic package for two of the three organic brigades consists of one light scout team (LST), two UH-1H helicopters and a maximum of fourteen infantrymen hereafter referred to as Aero-Rifles (to include one lieutenant) provided from D Troop, 3rd Squadron, 4th Cavalry.

(2) Composite Mini-Cav. The third organic brigade's Mini-Cav complement consists of one light scout team (LST) from D Troop, 3d Squadron, 4th Cavalry, a maximum of fourteen infantrymen, hereafter referred to as Aero-Rifles, who are assigned to the brigade and two UH-1H helicopters provided from a 1st Aviation Brigade Assault Helicopter Company (AHC). (Note: This support is from the AHC allocated to the brigade that day.)

b. Weapons, radios and equipment will be standard for TO&E infantry squads.

c. At the discretion of each brigade commander the Mini-Cav force may be modified, while remaining within the fourteen personnel limit, to allow use of Kit Carson Scouts, personnel from unit CRIPs, National Police and other GVN personnel.

d. The responsibility for unit training remains with the headquarters of the assigned personnel.

146

Incl 8

CONFIDENTIAL

**DOWNGRADED AT 3 YEAR INTERVALS:
DECLASSIFIED AFTER 12 YEARS.
DOD DIR 5200.10**

CONFIDENTIAL

AVDCOP

SUBJECT: Air Cavalry Package (Mini-Cav)(U)

4. (C) EMPLOYMENT. a. Each evening, prior to 1800 hours, the brigade S-3 will contact the Division Tactical Operations Center (phone CC 5213) or Lightning 33/96) and request the Mini-Cav package to report at a specific time and location.

b. Upon arrival at the reporting location, the brigade/battalion S-3 and S-2 must provide a briefing with current target areas, displacement of troops, intelligence and rules of engagement. As a minimum, the LST leader (AH-1G Aircraft Commander), the two UH-1H Aircraft Commanders and the infantry lieutenant should attend this briefing.

c. Type Operation. The procedure for utilization of the Mini-Cav is only limited by the imagination of the brigade commander. The one drawback to this force is its size. Consideration for the safety of the Aero-Rifles must dictate the employment. Results have been realized with the following type operations:

(1) Sniff. The LST organic to the Mini-Cav package can be employed with a UH-1 Sniff aircraft. Once significant readings are registered and the LST has made visual reconnaissance of the area, it may be appropriate to launch the Mini-Cav into the area. (The Aero-Rifles, while waiting to be launched, will remain with the lift aircraft monitoring a PRC-25 radio on the scout frequency.)

(2) LST Sighting. The LST organic to the Mini-Cav package can operate independently and once detecting a likely target, radio for the launching of the Aero-Rifles.

(3) Pre-Planned Intelligence Targets. Specific areas of interest, e.g. Yellow Jacket reports, POW debriefings, radar sightings, Hoi Chanhs, etc., can be targeted at the initial briefing of the key personnel of the Mini-Cav at the brigade/battalion TOC. In these cases the force can proceed to the target area and insert.

(4) Area Control. The use of Vietnamese National Police lends itself to area and population control. This pre-planned mission is executed with the force airborne and landing at locations where suspicious personnel are observed. This operation can quickly proceed from one area to another enabling extensive employment of the National Police with the Aero-Rifles primarily providing security.

(5) Stay Behind Patrols. As the two UH-1H aircraft proceed to extract the previously inserted Aero Rifles, a stay behind force can be aboard the aircraft (remaining concealed) and as the touch down is effected, the patrol disembarks prior to the extraction of the Aero-Rifles.

(6) Reaction Force for Aircraft Firing Incidents. Due to its inherent mobility, the Mini-Cav is the logical force to be employed against suspected firing positions. Note: All of the above operations can be modified to include deceptive landings, combining of operations, utilization/non-utilization of artillery preparatory fires, CS and PSYOPS.

147

CONFIDENTIAL

AVDCOP

SUBJECT: Air Cavalry Package (Mini-Cav) (U)

d. As a guide, the Aero-Rifles, once committed to an area, should not remain on the ground longer than thirty minutes. This is not intended to mean that a lucrative target will be abandoned, but rather that time should not be wasted on areas which do not produce results.

e. Once the Aero-Rifles are inserted, the LST is best used operating over and in front of them. The insertion of the Aero-Rifles usually is based on current intelligence or Scout/Sniff sightings. Thus the possibility of contact, or of flushing the enemy, is great. If the enemy attempts to evade the Aero-Rifles, the LST is free to destroy them as they make the attempt.

f. Once the Aero-Rifles are inserted, the UH-1H aircraft can either orbit the site or return to the fire support base. This decision is contingent on the enemy activity, proximity of fire support bases, weather conditions and fuel available.

g. Each day the brigades will designate a reaction force which will reinforce the Aero-Rifles as necessary.

5. (C) COMMAND AND CONTROL. The overall command of all Mini-Cav operations rests with the brigade commander in whose AO the Mini-Cav is operating. Depending on the type operation, two separate means for controlling the force can be used. These are:

a. When operating as a separate force. The LST leader will perform the functions of the Command and Control Aircraft. It will be his responsibility to insert the Aero-Rifles, call for artillery, direct the scout aircraft and determine when to extract. If it is necessary to reinforce the ground element, the control will pass to the battalion commander responsible for the reinforcing.

b. When operating in support of a battalion or in a battalion Area of Operations where the commander desires to control the assault. The function of command and control will rest with the battalion commander.

6. (C) COORDINATION.

a. The Mini-Cav is a complete entity, organized for specific type missions. It is necessary for the brigades to delegate missions to this force, but this should be tempered with the knowledge that this force is trained as a team. Fragmenting the package is not the intent of its employment. Specifically, the UH-1H aircraft should be with the Aero-Rifles once the troops are on the ground; and the Aero-Rifles should be employed only as a quick reaction force and not as listening posts, ambush patrols, etc.

b. The recommended daily flight time for the UH-1H helicopters is four hours each. This block of time, though not a rigid rule, is considered optimum to insure maximum insertions and efficient results. The

145

CONFIDENTIAL

AVDCOP

SUBJECT: Air Cavalry Package (Mini-Cav) (U)

brigade operating with the composite force will be more limited in that it is necessary to plan operations in accordance with II FFV instructions concerning the utilization of Assault Helicopter Companies. Blade time should not hamper operations, however the nine hour station time restriction must be adhered to.

7. (C) SUMMARY. The Mini-Cav, particularly during this stage of the war, has a tremendous potential. It is for this reason that maximum utilization is required combined with extensive imagination. The capability this force has for disrupting the enemy movement in this Tactical Area of Interest must be exploited.

FOR THE COMMANDER:

DISTRIBUTION:

B plus
10 - AAE
25 - G3

s/ L.E. Stith WO1 USA
for t/ LEWIS R. PARKHILL
1LT, AGC
Asst AG

A TRUE COPY:

Ralph J. Ballway
RALPH J. BALLWAY
MAJ, INF
Division Historian

149

CONFIDENTIAL

DEPARTMENT OF THE ARMY
18th Military History Detachment
25th Infantry Division
APO San Francisco 96225

AVDCME

19 November 1969

SUBJECT: Combat After Action Interview Report

THRU: Commanding General
United States Army, Vietnam
ATTN: Command Historian
APO San Francisco 96375

TO: Headquarters
Department of the Army
ATTN: O.C.M.H.
Washington, D.C. 20315

1. NAME AND TYPE OF ORGANIZATION: 1st Platoon, Company B, 2nd Battalion, 27th Infantry - Rifle Platoon.
2. INCLUSIVE DATES OF OPERATION: 12 October - 13 October 1969.
3. LOCATION: Ref Map Series L8020, Sheets 6231 III S and 6230 IV N, vicinity XT333163, Hieu Thien District, Tay Ninh Province, Republic of Vietnam.
4. CONTROL HEADQUARTERS: 2nd Battalion, 27th Infantry.
5. PERSONS BEING INTERVIEWED:
 - a. 1LT Terrence H. Hettig, 546564556, Platoon Leader, 1st Platoon, Company B, 2nd Battalion, 27th Infantry.
 - b. PFC Albert L. Brown, 186404072, Rifleman, 1st Platoon, Company B, 2nd Battalion, 27th Infantry - Ammunition Bearer for M60 machine gun positioned for rear security.
 - c. PFC Walter Black, 290463944, Assistant Machine Gunner, 1st Platoon, Company B, 2nd Battalion, 27th Infantry - Machine Gunner on M60 machine gun positioned for rear security.
6. INTERVIEWING OFFICER: Division Historian.

Incl 10

150

7. TASK ORGANIZATION: Nineteen (19) man combat patrol with three (3) Popular Force (PF) members attached. The Command Group consisted of the Platoon Leader, the Platoon Sergeant, and five (5) men. The 1st Section consisted of six (6) men and had the three (3) PF's attached. The 2nd Section consisted of six (6) men. The platoon was armed with two (2) M60 machine guns, two (2) M79 grenade launchers and 14 M-16 rifles. The PF's each carried an M-16 rifle.

8. SUPPORTING FORCES:

a. Battery B, 2nd Battalion, 77th Artillery (105mm), Fire Support Base Jackson, vicinity XT424166.

b. Mortar Platoon, Company B, 2nd Battalion, 27th Infantry (81mm), vicinity XT344179.

c. 2⁵th Aviation Battalion, one "Night Hawk" helicopter (UH1H).

9. BACKGROUND: The main infiltration route for enemy forces in Sub-Region 2 was the An Ninh Corridor which ran from the "Angel's Wing" in Cambodia into northern Hau Nghia Province. The 2nd Battalion, 27th Infantry was deployed to block the corridor with companies operating out of Fire Support Base Jackson (XT427168), Patrol Base Harris (XT417126), Patrol Base Kotrc (XT358148) and the Ap Bien Hoa Regional Force Outpost north of PB Kotrc (XT344179). (See Figure 1)

Patrol Base Kotrc (originally named PB Rittgers) was located in the An Ninh Corridor and was a bothersome obstacle to the enemy. The enemy lost 57 KIA trying to prevent the establishment of the patrol base on 12 August and an additional 17 bodies were left in the wire when the enemy attempted to overrun PB Kotrc on 5 September. Since its establishment the enemy had harassed the base with sporadic shellings.

Though the 2-27 Inf had succeeded in limiting the enemy's use of the An Ninh Corridor, elements at PB Kotrc and the Ap Bien Hoa RF Outpost continued to identify small enemy elements with radar and engage them with artillery. On the night of 11-12 October unusually heavy enemy activity had been detected in the vicinity of PB Kotrc.

Though most of the identified enemy activity was concentrated in the An Ninh Corridor, the enemy also operated north and south of the corridor.

Company B, 2nd Battalion, 27th Infantry was operating out of the RF outpost on the southern edge of Ap Bien Hoa. The three rifle platoons had been operating on a three-day cycle for over a month. The platoons were staggered so that when the 1st Platoon was in the first day of the cycle the 2nd Platoon was in the second day and the 3rd Platoon in the third. On the first day of the cycle the platoon performed a daytime ground reconnaissance followed by a night ambush. The second day was set aside for

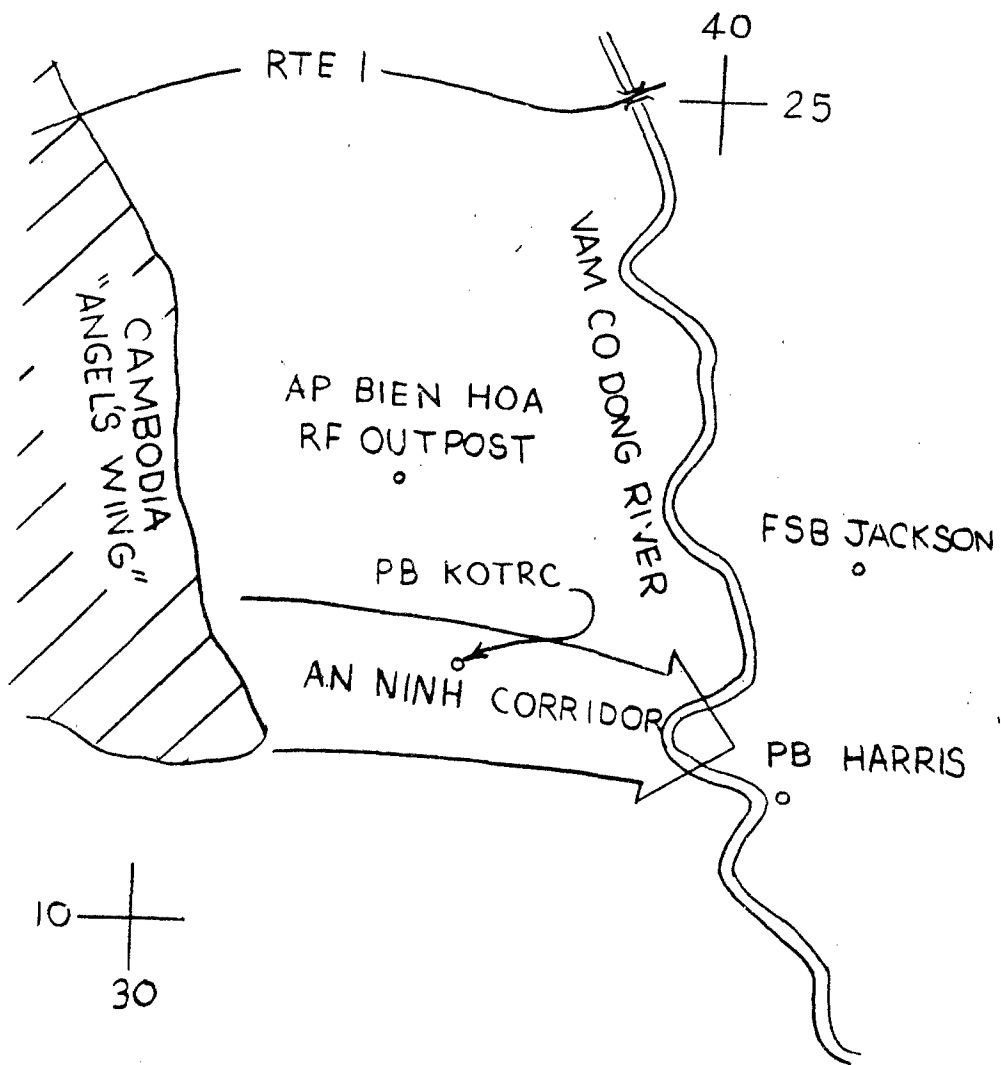

FIGURE 1 - AN NINH CORRIDOR
SERIES L607
SHEETS 6230 & 6231
SCALE 1:100,000

training and preparing for night activities at the RF outpost with another ambush that night. The third day and night were spent on rest, training, details, and helping to secure the outpost. When the reported action took place, the 1st Platoon was in the first night of the cycle.

For the daytime ground reconnaissance, Battalion Headquarters assigned a detailed mission, but night ambush locations were selected by the company commander within an area chosen by Battalion Headquarters.

10. INTELLIGENCE:

a. Enemy - Due to the heavy radar sightings the night before, some enemy action against PB Kotrc on the night of 12-13 October seemed likely.

b. Terrain - The area was flat with an elevation below five (5) meters and covered with rice paddies and scattered hedgerows. At the time of the action, late in the rainy season, the surface of the rice paddies was either mud or standing water. The Cambodian border was not blocked by any significant obstacles to foot movement.

c. Weather - At the time of contact, there were scattered clouds which presented no obstacles to operations.

11. MISSION: Company B was directed to set up ambushes between the RF outpost and PB Kotrc to cover the northwestern approaches to the base. The 1st Platoon was directed to establish an ambush in the vicinity of XT333158. The 2nd Platoon was assigned an ambush approximately 1200 meters to the north (XT333170).

12. CONCEPT OF OPERATION AND EXECUTION: When the 1st Platoon finished its ground reconnaissance it returned to the RF outpost for the evening meal, and to prepare for the ambush and await dark. At 1900 hours, they departed the outpost and moved toward their assigned location.

They moved south, paralleling a trail along adjacent rice paddies. The Platoon Leader stated he had little trouble navigating because they had been in the area so long that they could identify and locate many fish traps, sun screens and other similar structures in the area. He set up the ambush north of the planned location when he found a dry area approximately 10 meters wide and 25 meters long and the same height as the rice dikes, near the trail with several rice dikes running into it. (See Figure 2)

After selecting the site, the Platoon Leader established his ambush position in a rough triangle. The Command Group was positioned on the west side facing the trail, the 2nd Section on the north side, and the 1st Section with the PF's on the southeast side. The M60 machine guns were placed on the southern and eastern corners. The M60 machine gun on the eastern corner was located at the junction of two rice dikes coming into the position from the east and north. Following SOP, claymore mines were put out 15 paces from

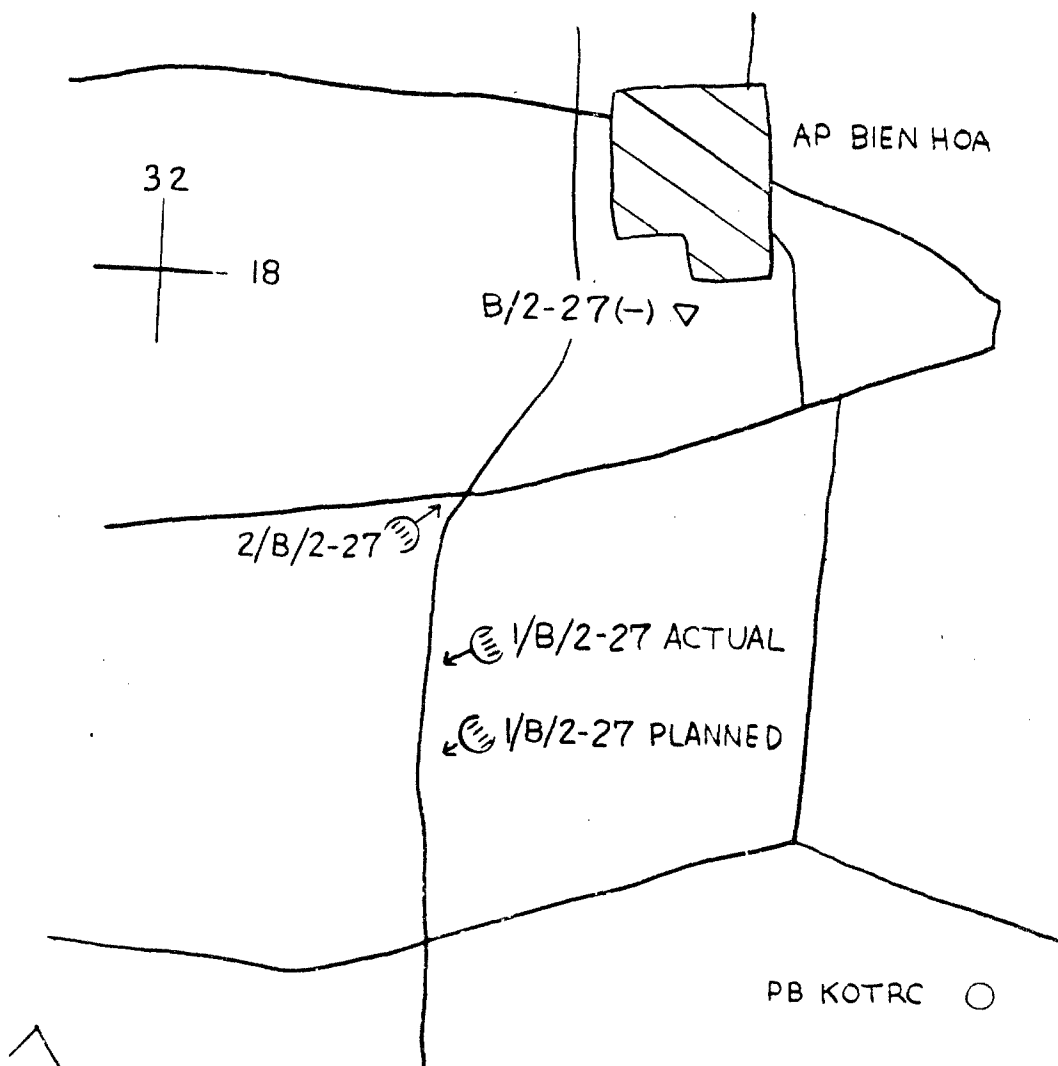
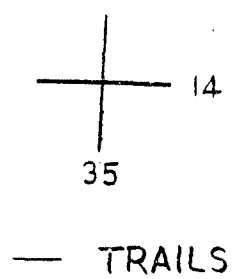

FIGURE 2 -
 UNIT LOCATIONS
 SERIES L8020
 SHEETS 6230 IV N &
 6231 III S
 SCALE 1:25,000
 154



the position and then emplaced on the nearest dry spot. (See Figure 3)

By 2145 hours, the platoon had established its position. At 2239 hours, the Platoon Leader was contacted by the company's Artillery Forward Observer who informed him that the radar at PB Kotrc had detected movement east of the patrol which would be engaged with artillery. The Forward Observer also warned him that enemy elements could be expected to approach his position from the east. The Platoon Leader said that by 2253 hours the artillery was so loud he was no longer concerned that any of his men might fall asleep since the artillery was impacting only 600 meters east of the platoon.

At 2255 hours, the ammunition bearer for the machine gun on the eastern corner, PFC Albert L. Brown, saw six (6) enemy running along the rice dike leading to the position from the east about 25 meters away. The machine gunner, PFC Walter Black, saw the enemy soldiers just after PFC Brown did. The six (6) enemy soldiers were running in a file directly at the machine gun. When the enemy was approximately five (5) meters from the machine gun, PFC Brown fired a burst from his M-16 rifle and PFC Black began firing his M60 immediately afterward. As the two fired, the other members of the platoon who were in a position to do so joined in the firing. The grenadiers began firing M79 illumination rounds behind the kill zone. PFC Black had fired about 150 rounds through his M60 when the weapon had a stoppage. He found that the ammunition belt was caught on another belt lying beside the weapon and had the weapon operational in a matter of seconds. The maximum rate of fire lasted approximately two (2) minutes. During this time, the claymore mines emplaced on the eastern side of the position were detonated. PFC Brown said that, during the firing, he expended about 15 magazines of M-16 ammunition.

The two men who initiated the firing stated that they saw four of the enemy fall in the initial firing with the fifth running to the north and the sixth running to the south. Apparently, two of those who fell were only wounded since only two bodies were found in front of the machine gun.

When the firing began, the Platoon Leader moved to the eastern corner of the position to control the action. For about eight (8) minutes after the initial two (2) minutes of firing, the remaining enemy were engaged with aimed fire when they could be seen attempting to flee the area. To supplement the M79 illumination, which was now being fired by only one of the grenadiers while the other fired high explosive rounds, the platoon used hand-held parachute flares and star clusters.

As soon as the contact was reported, a "Night Hawk" helicopter from the 25th Aviation Battalion which had been operating in the vicinity of PB Kotrc was diverted over the contact. The ship arrived over the ambush at 2258 hours. The flares on the "Night Hawk" were used to replace the M79 illumination and hand-held parachute flares, and the helicopter flares

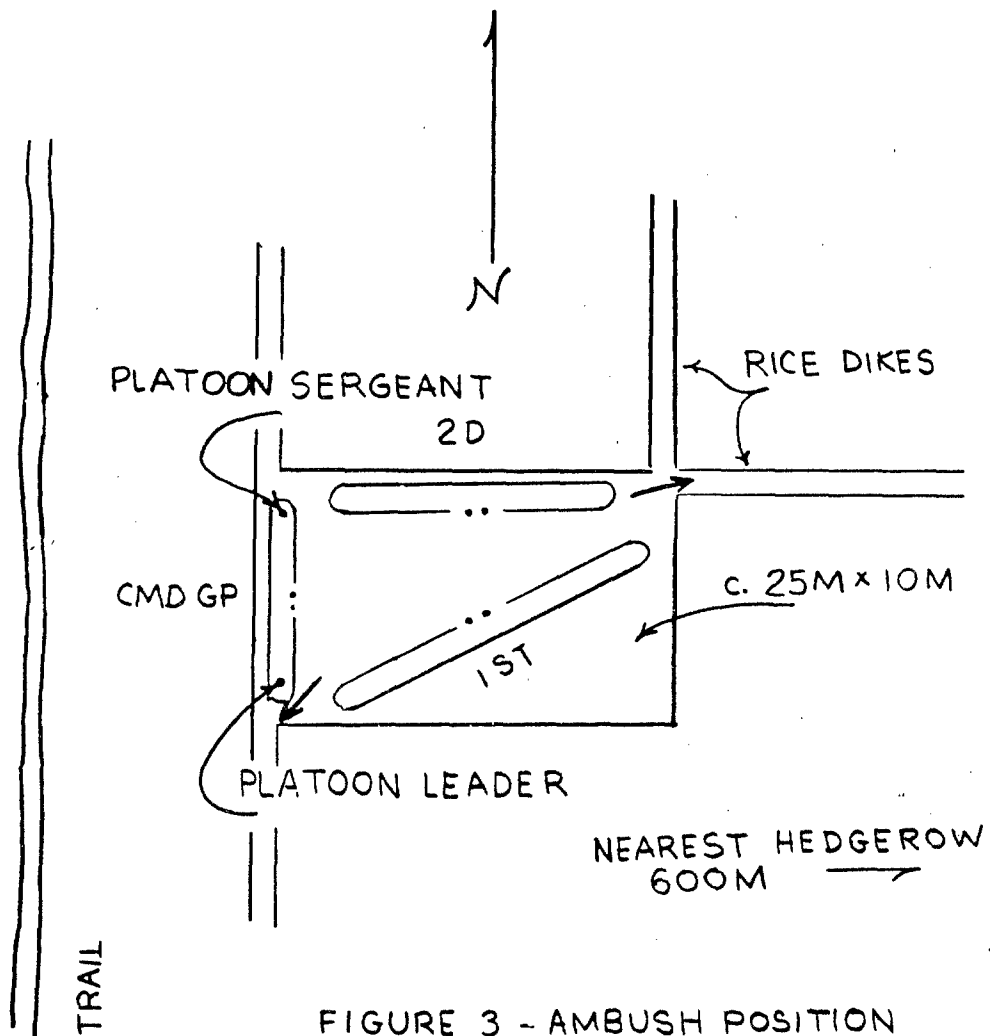

FIGURE 3 - AMBUSH POSITION
NOT TO SCALE

were in turn replaced by 81mm mortar illumination. Finally, fifteen (15) minutes of 105mm artillery illumination was employed. As soon as it arrived, the "Night Hawk" began using its spotlight to find targets for its minigun. The helicopter engaged one of the enemy who had moved north out of the kill zone.

After engaging the target at about 2303 hours, the "Night Hawk" requested that the platoon check their target to see if he was still alive. By this time, the platoon could no longer see any targets from their position and the Platoon Leader had organized a killer group. 1LT Kettig said his main problem in organizing the killer group was that everyone wanted to go. The killer group was sent out to the south to check the area where the machine gunner on the southern corner said he saw two enemy fall after he fired the M60 at them. When the "Night Hawk" radioed that they had a dead or wounded enemy marked with their spotlight, a second killer group comprised of five men, including the platoon medic and a radio operator, was sent to the north.

When the first group moved out, they first checked the initial kill zone and located two enemy bodies. Then, they swung south and spotted one of the enemy crawling away. They engaged and killed him. They did not find the second enemy who was thought to have evaded south after the original firing.

The second group was guided to the "Night Hawk's" target by the helicopter spotlight which was narrowed as the group approached to pinpoint the target. When the enemy soldier was found, he was suffering from a sucking chest wound which the medic immediately treated. After first aid had been applied, the helicopter landed to evacuate the severely wounded man. There was no sign of the second man who was thought to have evaded to the north. (See Figure 4)

During their search, the killer groups found three (3) M16 rifles, a pouch with ten (10) new M26 grenades, a satchel charge, and several portable bamboo tripods.

When the killer groups returned to the ambush position, the platoon was ordered to join the 2nd Platoon to their north. At 2330 hours, after collecting their gear, they moved out toward the 2nd Platoon.

As they neared the 2nd Platoon's position, they fired a green star cluster as a recognition symbol and, by 2340 hours, were in place, having taken over a portion of the 2nd Platoon's perimeter.

Although the evacuated prisoner was fatally wounded, he stated before he died that his mission for the night had been to carry ammunition to a village which was close to PB Kotro. This information was received at the Division Tactical Operations Center (DTOC) at about 0055 hours. Feeling that this information, coupled with several radar sightings to its west,

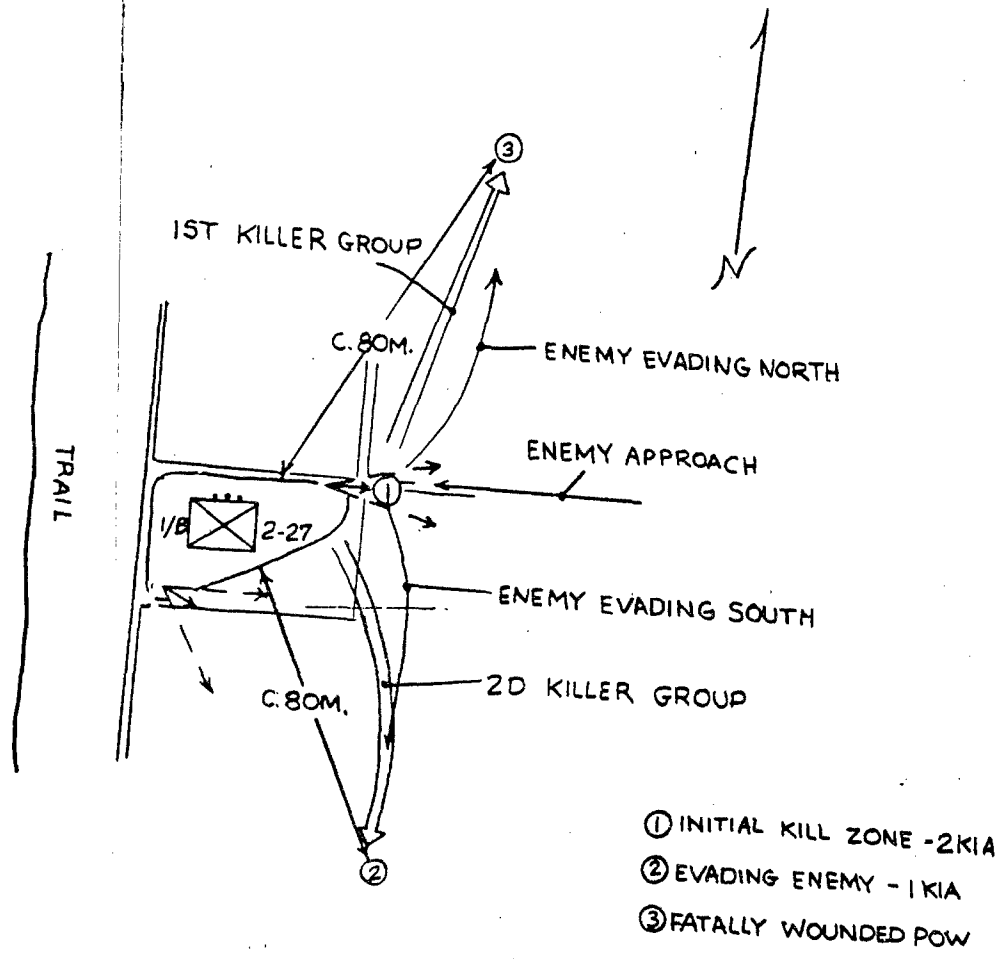

FIGURE 4 - AMBUSH & SEARCH
NOT TO SCALE

indicated that an attack on PB Kotrc was imminent, DTOC dispatched a light fire team and a helicopter flare ship to the area. The attack began at 0100 hours, shortly before the helicopters arrived over the area. The enemy shelling during the attack included three (3) 122mm rockets.

The 1st and 2nd Platoon's ambush position had no contact with the enemy. At about 0530 hours, the 1st Platoon left the 2nd Platoon's ambush site to return to the RF outpost where they closed at 0600 hours.

After breakfast, the Company Commander led the 3rd Platoon, augmented by several volunteers from the 1st Platoon, to search the area where the ambush patrol had engaged the enemy. They found the three bodies which had been located the night before and a fourth body, along with another AK-47 rifle and two homemade hand grenades. They also found more of the bamboo tripods, bringing the total to ten.

The tripods were a type the VC/NVA use as a lightweight field launcher for 122mm rockets. The tripods and the prisoner's statement indicated that the six enemy who had been ambushed were part of an element that was to have provided fire support for the attack on PB Kotrc.

1LT Rettig stated that the Platoon had no significant contact for months and had suffered a morale problem from working hard for so long with no results. He estimated that morale improved "ten times" as a result of the ambush.

13. ANALYSIS: By allowing the enemy to close within five (5) meters before engaging them, PFC Brown and PFC Black insured that the ambush would achieve maximum shock even though only two weapons were initially fired. The tactical unity of the enemy group was shattered; they were unable to fire a single shot in return and were reduced to disorganized, fleeing individuals.

This action shows the value of the combination of radar, artillery and aggressive patrolling in preventing organized enemy attacks on U.S. bases. The radar and artillery prevented the enemy from organizing and massing for his attacks as he had planned, and in this case, the ambush changed the disorganization and casualties the artillery had caused into a defeat in detail. When the enemy launched what he could collect of his planned attack, he was short part of his fire support and was headed for an alerted patrol base with aviation support already on the way. The disorganized attack was unable to inflict a single US casualty, and cost the enemy seven (7) killed in addition to the five (5) killed by the ambush.

14. RESULTS:

- a. Friendly casualties and losses: None.
- b. Enemy casualties: 5 KIA (BC).

c. Enemy equipment losses:

- (1) 4 AK-47 rifles
- (2) 10 M26 grenades
- (3) 2 homemade grenades
- (4) 1 satchel charge
- (5) 10 bamboo tripods for 122mm rockets

d. 1/B/2-27 Inf ammunition expenditures (approximate):

- (1) 700 rounds M60 ammunition
- (2) 540 rounds M-16 ammunition
- (3) 30 rounds M79 illumination
- (4) 15 rounds M79 HE
- (5) 7 Claymore mines
- (6) 3 hand grenades

W.D. Watson
WILLIAM D. WATSON
CPT, FA
Commanding

CONFIDENTIAL

DEPARTMENT OF THE ARMY
18th Military History Detachment
25th Infantry Division
APO San Francisco 96225

AVDCMH

31 January 1970

SUBJECT: Combat After Action Interview Report

THRU: Commanding General
United States Army Vietnam
ATTN: Command Historian
APO San Francisco 96375

TO: Headquarters
Department of the Army
ATTN: O.C.M.H.
Washington, D.C. 20315

1. (U) NAME OF OPERATION: Cliff Dweller IV.
2. (U) DATES OF OPERATION: 04 January - 11 January 1970.
3. (U) LOCATION: Northeastern slope of Nui Ba Den (XT2860); Sheet Number 6231 IV N and IV S, Map Series L8020, 1:25,000; Phu Khuong District, Tay Ninh Province.
4. (U) CONTROL HEADQUARTERS: 1st Brigade, 25th Infantry Division.
5. (U) PERSONS BEING INTERVIEWED: See Inclosure 1.
6. (U) INTERVIEWING OFFICER: Division Historian.
7. (U) TASK ORGANIZATION:
 - a. Companies A, B, C, D and Reconnaissance Platoon, 3rd Battalion, 22nd Infantry.
 - b. Company A, 2nd Battalion, 34th Armor.
 - c. Company A and one platoon, Company D, 4th Battalion, 9th Infantry.

Incl 11

161
CONFIDENTIAL

**DOWNGRADED AT 3 YEAR INTERVALS;
DECLASSIFIED AFTER 12 YEARS.
DOD DIR 5200.10**

CONFIDENTIAL

8. (U) SUPPORTING FORCES:

a. Artillery.

- (1) Battery B, 7th Battalion, 11th Artillery.
- (2) Battery C, 3rd Battalion, 13th Artillery.
- (3) Battery A, 7th Battalion, 9th Artillery.
- (4) Battery B, 1st Battalion, 27th Artillery.

Note: During the period 4-12 January 1970, a total of 12,653 artillery rounds were fired, of which 648 were used on the landing zone preparation on Nui Cau.

b. Army Aviation.

- (1) Company A, 25th Aviation Battalion (Little Bear) - CS and Flame Bath drops, resupply and MEDEVAC.
- (2) Company B, 25th Aviation Battalion (Diamondhead) - Light Fire Teams.
- (3) 1st Brigade Aviation LOHs (Yellow Jacket) - MEDEVAC.
- (4) 187th Assault Helicopter Company (Crusaders) - Provided all lift support except extractions.
- (5) 242nd Assault Support Helicopter Company (Muleskinner) - Resupply.
- (6) Troop D, 3rd Squadron, 4th Cavalry (Centaur) - Light Fire Team, Visual Reconnaissance.
- (7) Company A, 2nd Battalion, 20th Aerial Rocket Artillery (Blue Max) - Helicopter gunships.

c. United States Air Force.

- (1) Air Force Forward Air Controllers (OV-10).
- (2) F-100 Tactical Fighters - Air Strikes.
- (3) AC-119 (Shadow) - Gunship, flareship.

9. (U) BACKGROUND INFORMATION: The primary mission of 1st Brigade, 25th Infantry Division is to destroy VC/NVA forces and their bases of operation; assist the Republic of Vietnam in rural development, pacification and civic

CONFIDENTIAL

162

CONFIDENTIAL

action programs; assist in training and provide support to RVNAF; and be prepared to reinforce US and ARVN forces within the TAOI as directed.

10. (C) INTELLIGENCE:

a. Enemy - Nui Ba Den is a headquarters location of elements of the "shadow" government, a staging area for attacks on Tay Ninh City and other allied installations in Tay Ninh Province, and a stopover point on the infiltration route through War Zone "C" from Cambodia to the 25th Infantry Division TAOI. Operation Cliff Dweller IV was one of a series of denial operations carried on by 1st Brigade on Nui Ba Den. In executing this operation, 1st Brigade assigned to the task the largest number of US troops ever to operate on Nui Ba Den mountain.

b. Terrain - The terrain of Nui Ba Den is unlike any other in the Division AO. The ancient granite mountain is very steeply sloped, covered with enormous boulders, honey-combed with caves, crevasses and tunnels, and low, tangled undergrowth covers the greater part of the slopes (except for rock slides).

c. Weather - Generally the weather was very good - partly cloudy skies, not excessively warm. The altitude of Nui Ba Den allows for more cooling breezes than is normally experienced in other areas of Tay Ninh Province. The one natural phenomenon which caused a problem was that of drafts on the slopes of the mountain. Helicopters which were attempting to resupply US forces on the slopes of the mountain were unable to maintain position during the supply drops because of the heavy updrafts and downdrafts.

11. (U) MISSION: The primary concept of Operation Cliff Dweller IV was to sweep the northeastern slope of Nui Ba Den, killing and/or capturing as many enemy as possible to include supplies and materials which could be used by the enemy.

12. (C) CONCEPT OF OPERATION AND EXECUTION:

On 4 January 1970, Operation Cliff Dweller IV commenced. The concept of the operation was to have two infantry companies sweep down the northeastern slope of the mountain and set up blocking positions a short distance from the bottom. (See Inclosure 2) A third infantry company would sweep the base of the mountain from southeast to northwest, link up with the other two companies and all three would sweep through the rock slide area (XT279603) to the base of the mountain. Supporting forces would be placed off the mountain, north and south of the rock slide area and on Nui Cau from which a commanding view of the area of operations is afforded.

At 0800 hours on 4 January the first of eight CH-47 sorties landed

CONFIDENTIAL

CONFIDENTIAL

Companies B and C, 3rd Battalion, 22nd Infantry on Nui Ba Den at the Provisional Company installation (XT281582). Between 0915-0935 hours a four ship lift inserted the Reconnaissance Platoon, 3-22 Inf on Nui Cau (XT271-605) where they established a blocking position 200 meters east of the crest of Nui Cau (XT273605) and remained in that position for the duration of the operation. Companies B and C began moving down the northeastern slope of Nui Ba Den on two axes, Company B on the right axis, Company C on the left axis. Because of the difficulty of movement in such terrain, B,C/3-22 Inf progressed about 40% of the way down the mountain on the first day. At 0934 hours on 4 January the demolition team from Company A, 65th Engineer Battalion attached to C/3-22 Inf destroyed a booby trapped US fragmentation grenade approximately 150 meters from the line of departure.

Night defensive positions were established at approximately 1830-1900 hours as further progress was halted by the ensuing darkness. Company C established its night defensive position approximately 1700 meters north of the crest of Nui Ba Den (XT279598). Company B established its night defensive position approximately 1200 meters northeast from the crest of Nui Ba Den (XT288591). Some enemy probings were suspected during the first night but no actual contact was established. Because of the terrain on the mountain it was difficult for the units to establish perimeters as would be done on more favorable terrain. To offset this difficulty a series of strong points were established to serve as a perimeter, the most effective method of securing a night defensive position in such terrain.

Earlier on 4 January (0645 hours), Company A, 2nd Battalion, 34th Armor (-) and the 548 Regional Force Company occupied a blocking position at the northeastern base of the mountain (XT279608). Slightly to the southeast (XT293598), one platoon of tanks from A/2-34 Arm (-) and one platoon, Company D, 4th Battalion, 9th Infantry established a second blocking position. Artillery support was provided by Battery C, 3rd Battalion, 13th Artillery and from 6 January on, one platoon of Battery B, 7th Battalion, 11th Artillery at Fire Support Base Bragg (XT334579). Security for the artillery was provided by one platoon, Company C, 4th Battalion (Mechanized), 23rd Infantry and the 163 Regional Force Company.

The first contact on 4 January occurred at 1925 hours when a sniper attached to Rcn/3-22 Inf observed and engaged three enemy soldiers 300 meters south-southeast of the sniper's location with three rounds of M-14 killing one of the enemy.

At 0005 hours on 5 January an ambush position of Rcn/3-22 Inf smelled marijuana and detected movement 35-40 meters below their position to the east. Engaging the movement with hand grenades and sniper fire, one enemy soldier wearing black pajamas was killed. No return fire was received. The dead soldier was searched but he had neither weapons nor documents on him.

CONFIDENTIAL

CONFIDENTIAL

At approximately 0700-0730 hours on 5 January B/C/3-22 Inf continued the sweep down the mountainside. Because of rain the previous evening movement was very slow due to the rocks being slippery and wet. Very little forward progress was made the second day. About noon a 14 ship lift inserted Company A, 3rd Battalion, 22nd Infantry in a landing zone secured by 1/A/2-34 Arm and 1/D/4-9 Inf. The company's mission was to execute a detailed reconnaissance from southeast to northwest along the base of the mountain to 200-300 meters up the slope. Companies B and C moved down the slope to set up a blocking position above the area to be swept by A/3-22 Inf. As Company A swept, Company B on the southernmost axis would swing behind Company A to protect its rear. Company C afforded protection from enemy fires from above.

Company A located one tunnel with a room attached (10x20x30) at 1635 hours (XT293595). Uncovered were a small VC camp with cooking area, two truck batteries, clothing and web gear. The room was large enough to accommodate 35 individuals. There were signs of recent activity within the last 72 hours. At 1945 hours Company E observed movement and a light 400 meters west of their night defensive position (XT289594). Engaging the movement with organic weapons all movement ceased and the light went out. At 1150 hours on the next day (6 January), A/3-22 Inf on a reconnaissance of this contact area located 12 graves containing 12 enemy killed by small arms fire. No weapons or documents were uncovered. The enemy dead were wearing green NVA uniforms.

Operation Cliff Dweller IV continued as planned on 6 January. Company B moved out of its night defensive position at 0700 hours and continued to the bottom of the mountain where another night defensive position was established. Just before setting up, elements of B/3-22 Inf located three caves which they reconnoitered with fragmentation grenades. No return fire was received. Company A continued moving across the lower slope of the mountain towards the rock slide area to the northwest (XT279603). Company C moved to within 400 meters of the base of the mountain and established a night defensive position.

The last day of Operation Cliff Dweller IV was originally scheduled to be 7 January. But because of the contact made by B/3-22 Inf the previous day the operation was extended. (See Inclosure 3) During the 7th, the platoon from D/4-9 Inf securing the tank platoon of A/2-34 Arm at the southernmost blocking position was relieved by a Regional Force Company.

At 1030 hours Company B while searching a cave (XT288599) located seven US M-1s, one SKS carbine, two M-72 LAWs, nine M-16 magazines (fully loaded), one can with 400 rounds of M-1 ammunition, one RPG round, one ChiCom hand grenade, one VC gas mask, one NVA shovel, four US poncho liners, two US canteens, one first aid packet, two bars of soap, US soy bean oil, C-ration cans, one fish net, one towel, four female pants, four sets of underwear with bells (female), one garden (15x20) and two enemy

CONFIDENTIAL

165

killed by small arms fire and fragmentation grenades (accredited to A/3-22 Inf reconnaissance by fire of the cave the previous day). All explosives were destroyed by the demolition team from A/65th Engr and the weapons were sent to Tay Ninh Base Camp.

At 1600 hours Company B located ten pounds of documents in a cave. Later information revealed that the documents consisted of tax receipts, meeting reports, envelopes, financial reports and medical certificates which mainly concerned the Toa Thanh District unit and District Committees, and a list of changes in LBNs (Letter Box Numbers) for the Toa Thanh (D) Sections and Associations to have become effective 17 September 1968. Because of the nature of the terrain it was impossible to tell whether or not there had been recent activity in the area. Fifteen minutes later (1615 hours), B/3-22 Inf observed eight enemy evading into a cave (XT286-600). US forces attempted to get the enemy to Chieu Hoi, but were answered with fragmentation grenades, wounding three US soldiers. At 1820 hours the cave was engaged with CS and multi-shot flame thrower resulting in all eight of the enemy being killed.

The Reconnaissance Platoon observed one individual 125 meters northwest of their position at 2045 hours. Engaging the enemy with organic weapons, one enemy soldier was killed.

Beginning on 8 January and lasting for the next two days till the operation ended on 11 January, US forces came under almost constant enemy fire during daylight hours - mostly in the form of highly accurate sniper fire from well-entrenched enemy elements. As US forces neared the area of the rock slide, enemy fires increased in their intensity. Only when forward movement slowed did the enemy fires slacken.

As Company A came adjacent to Company C's flank at about 0750 hours on 8 January (XT276604), heavy contact was established. The left point of Company C first received fire from 3-4 enemy at about 0800 hours. When return fire from M60 machine guns were placed on the enemy snipers, US forces began to receive a heavy volume of fire. The enemy returned fire with small arms, RPGs, sniper fire and M-79 CS rounds. As infantry elements engaged the enemy with organic weapons, air support saturated the area with fires from six light fire teams, three CS drops, one "Flame Bath" drop and seven TAC air strikes. Four artillery batteries (1827 rounds), main tank guns and automatic weapons fire from blocking forces were also brought to bear against the enemy all day.

A break in contact occurred at 0835 hours. Five minutes later Company A received small arms and RPG fire from an estimated enemy platoon from several small caves. The enemy continued to fire at US forces throughout the rest of the day, mainly sniper fire. Movement was extremely difficult because of the terrain and the necessity for US soldiers to expose their position when moving. Due to these factors, plus the highly

CONFIDENTIAL

166

CONFIDENTIAL

accurate enemy sniper fire, Company C was able to move only about 50-75 meters during the first two days of contact. At 1344 hours a resupply helicopter from Company A, 25th Aviation Battalion was hit by an RPG round. The helicopter crashed and burned. Three US personnel were wounded by shrapnel. The helicopter was totally destroyed. The helicopter was to be used to MEDEVAC two wounded US personnel. The two wounded US personnel awaiting MEDEVAC were killed by AH-1G (Cobra) rocket fire as the helicopter gunship was making a firing run to cover for the downed helicopter and its crew. This tragic accident would have never occurred had it not been for the close contact in which the US forces were involved and the confusion caused by intense enemy small arms and automatic weapons fire. Just prior to this incident a Kit Carson Scout was killed by an explosion of unknown origin. The Kit Carson Scout and two US personnel were attempting to move toward the downed helicopter when ordered by their platoon leader to withdraw. Just as the men started to make their withdrawal there was an explosion which knocked all three men to the ground. The two US personnel were not wounded but the Kit Carson Scout was killed by the concussion from the explosion. No cause for the explosion could be determined. This Kit Carson Scout (Tran Van Oi) and another Kit Carson Scout (Tran Van Vien) have been recommended for the award of the Silver Star for their bravery and valor during this operation.

At approximately 1800 hours the enemy broke contact. US forces established night defensive positions in place. No further contact was established during the ensuing period of darkness. Sixty-two enemy had been killed on this first day of heavy contact. After completing searches of the contact area, US forces evacuated one M-1 carbine, one SKS rifle, ten pounds of documents and five pounds of medical supplies. Six US soldiers were wounded during the initial enemy fires.

At 1958 hours on 8 January a member of Rcn/3-22 Inf was killed by enemy sniper fire. The soldier was helping unload a resupply drop amid moderate enemy sniper fire when the incident occurred.

On 9 January Company D, 3-22 Inf relieved A/3-22 Inf in place at 1500 hours. Company A moved 1.5 kilometers east of the mountain and was extracted to Tay Ninh Base Camp. Company D received sniper fire at the landing zone and all the way to Company A's position. Company D's mission was to sweep up the area of the rock slide and move up to the "saddle". Because of the accurate sniper fire D/3-22 Inf was unable to make any progress up the slope toward the enemy positions and remained in place until pulled off the mountain on 11 January. At 1600 hours Company A, 4th Battalion, 9th Infantry landed on Nui Cau and moved to the position secured by Rcn/3-22 Inf where the Company remained the night of 9 January.

During the morning hours of 9 January three tubes of 105mm howitzer of Battery B, 7th Battalion, 11th Artillery moved to the northern blocking position of A/2-34 Arm (-) to provide more accurate and direct artillery support. The 548 Regional Force Company securing this position was

CONFIDENTIAL

CONFIDENTIAL

replaced by B/3-22 Inf (-) during the afternoon of 9 January. One platoon from Company B provided security for the tank platoon at the southern blocking position. Company B would also act as a reaction force in support of the remaining 3-22 Inf elements on the mountain.

At 1000 hours on 9 January A,C/3-22 Inf received heavy sniper fire from an unknown number of enemy as the units continued to close on the enemy force in the rock slide area. US forces were attempting to sweep the hillside near the rock slide area but because the enemy was so well-entrenched that to continue trying to move forward too many casualties would be sustained. Securing the positions they had advanced to, US forces returned the enemy fire with organic weapons, one CS drop, five light fire teams, eight TAC air strikes, five "Flame Bath" drops and three artillery batteries killing 47 of the enemy in contact which lasted all day long. Two US soldiers were wounded during the initial enemy fires, the only casualties of the action. At 1430 hours a MEDEVAC helicopter received heavy ground fire but suffered no casualties.

All during the three days of contact heavy enemy fires were directed at the resupply and MEDEVAC helicopters supporting the operation. Whenever helicopters approached the mountain on a mission the majority of enemy fire would be directed at them. A few of the enemy would try to place spraying suppressive fire on the US forces to protect other enemy soldiers who exposed themselves in the hope of damaging or destroying a helicopter. Though faced with this additional danger, resupply and MEDEVAC helicopters carried out their missions in a most admirable manner.

Fighting continued through most of the day (9 January), slackening off by mid-afternoon. Sporadic small arms fire was exchanged until approximately 1800 hours. During the night of 9-10 January the contact area was intermittently engaged by PSIOP broadcasts, helicopter gunships and artillery.

As dawn broke on 10 January US infantry elements again moved against the enemy forces entrenched in the cave-strewn area of the rock slide. Company A, 4-9 Inf moved down to the "saddle" at 0700 hours. Five hours later the Company moved 150 meters down from the "saddle" to establish a blocking position above the area of contact of C,D/3-22 Inf. At 0830 hours B,C,D/3-22 Inf and A/4-9 Inf began receiving small arms and RPG fire. US forces returned fire with organic weapons, one light fire team, three TAC air strikes, two "Flame Bath" drops and three artillery batteries (1648 rounds) during the day long contact. At 0837 hours all firing ceased briefly. Enemy small arms and sniper fire began again at 1015 hours and abruptly ceased at 1025 hours.

As US forces continued to press the advantage the enemy continued his resistance. Firing picked up again at 1225 hours as the enemy directed

CONFIDENTIAL

CONFIDENTIAL

heavy small arms fire against approaching US forces. Fighting continued sporadically throughout the day until 1750 hours. Twenty enemy killed were credited to US fires.

The northern blocking force (XT286612) received a heavy volume of RPG and mortar fire at 1525 hours. Seven US soldiers were wounded by this attack by fire which ceased ten minutes after it began.

At 1430 hours on 10 January snipers attached to A/4-9 Inf observed three enemy approximately 300 meters from their position. One of the enemy was wearing camouflaged fatigues and a steel helmet. Engaging this enemy with one round of M-14 fire, the sniper killed the enemy soldier. A second round was fired at another enemy but he disappeared before a kill could be confirmed.

During the evening hours (2200 hours), A/2-34 Arm (-) observed one individual moving 35 meters southeast of its position. Engagement with organic weapons resulted in the enemy soldier being killed.

On 11 January Operation Cliff Dweller IV came to an end. It was decided by the 1st Brigade Commander with concurrence of the Commanding General, 25th Infantry Division that no further significant results warranted a commitment of such a large force to extending the operation. To provide direct support during the withdrawal of American forces, two 175mm howitzers from Battery A, 2nd Battalion, 32nd Artillery and two Quad-50's from 5th Battalion, 2nd Artillery moved on the morning of 11 January to just northeast of the contact area. All US forces moved off the mountain and returned to their base of operations.

By the afternoon of 11 January all US elements had been withdrawn from the mountain. An unexplained phenomenon noted during the withdrawal stage of the operation was that as the US forces moved off the mountain they received no enemy fire. Because of the terrain US troops had to expose themselves to possible enemy fire as they moved down and off the mountain. Not one round of enemy sniper, small arms or RPG fire was directed against these troops. Remaining in position until the morning of 12 January, A/2-34 Arm and B/3-22 Inf maintained surveillance over and placed direct and indirect fire on suspected enemy locations.

The 1st Brigade S-3 Daily Staff Journal noted that the Tay Ninh Province Chief stated that the enemy elements involved in the contact on the mountain were the F-31 and F-51 Sapper Battalions of the 271 NVA regiment. This report has not been confirmed through captured document readouts or identification by any other means. On 19 May 1968 the F-31 Sapper Battalion was involved in an attack on the signal installation atop Nui Ba Den and therefore may still have elements in the area, possibly targeted with the same mission.

CONFIDENTIAL

13. (C) RESULTS: Operation Cliff Dweller IV was another in a series of successful denial operations on Nui Ba Den carried out by 1st Brigade maneuver and support elements. Enemy personnel losses during the seven day period were 156 killed. US forces suffered three men killed and one Kit Carson Scout was killed. Fifty-five American soldiers were wounded, of whom eight were evacuated for further treatment. The remaining wounded returned to their units after a short period of convalescence.

The inability to use Nui Ba Den as a refuge seriously hurt the enemy plans to mount a coordinated, effective offensive in Tay Ninh Province. This area had long been a refuge for enemy elements staging for attacks on Tay Ninh City. Operation Cliff Dweller IV drastically reduced the enemy potential to mount a significant offensive without heavily reinforcing the forces remaining in the mountain refuge.

14. (C) ANALYSIS:

a. Because of the type of terrain in which this operation took place, many problems were encountered, not all of which could be successfully countered.

(1) Resupply.

(a) US infantry elements required a much larger rate of expenditure of smoke grenades to mark their positions for resupply drops and MEDEVACs, and for identification of friendly positions by supporting fires. (See Inclosure 4 for resupply to 3rd Battalion, 22nd Infantry)

(b) US equipment losses were abnormally high due to the difficulty troops had in maneuvering in the rock-stream terrain.

(c) Resupply missions were extremely difficult to complete due to air turbulence on the slopes of the mountain; inability of resupply helicopters to place loads where directed due to irregular, steep terrain; heavy volume of enemy sniper fire directed at resupply helicopters; loss of resupply loads into holes and crevasses; loss of resupply loads due to "drop-off" method; the dropping of resupply loads into areas inaccessible to US troops; and the problems always involved in night resupply missions. Pathfinders were used to control supply drops and even though faced with almost insurmountable problems managed to complete many more resupply missions than was expected.

(d) The loss of water resupply, caused by the necessity of dropping loads rather than placing them in predetermined locations, and the loss of equipment, caused by operating in such unfavorable terrain, were two major problems encountered during resupply missions.

b. Communications. Though there were no reported failures in or

170
CONFIDENTIAL

CONFIDENTIAL

loss of communications equipment, the battalion command net used while contact was in effect became heavily loaded at times.

c. Tactics. An interesting innovation employed by Company C, 3rd Battalion, 22nd Infantry is the Point Squad. The point squad is an eight-man, all-volunteer element which acts as a forward reconnaissance element. Because the unit acts only in this capacity, it has built up the experience needed to perform the role of "point" more professionally than could the rotating point-man system. The squad consists of a well-experienced NCO, one "tunnel rat", one grenadier, one M-60 machine gunner and four team members. The success experienced with the point squad has been more than satisfactory.

d. Snipers. All during Operation Cliff Dweller IV US forces received almost continuous enemy sniper fire. Though there is no conclusive evidence available, a number of unit commanders remarked that the highly consistent accuracy of sniper fire was due to the possibility that the enemy snipers were trained for that mission and they could have been aided by telescopic sights in this mission. It was noted that enemy snipers did use tracer rounds so as to make corrections while firing.

e. The Combat Engineer Vehicle (CEV), Company A, 65th Engineer Battalion successfully used several innovative techniques during Operation Cliff Dweller IV.

(1) The CEV devised a plan to afford more protection for US infantry elements providing security for the southernmost blocking position. When arriving at this position on 8 January the vehicle commander used the CEV blade to build a berm 3-4 feet high between the tanks to protect the infantrymen. This not only gave the infantryman a berm in front of him but also a depression behind the berm for further protection. On 11 January the CEV leveled the berm, filling in all holes, after the blocking force had completed its mission and were returning to their respective bases of operation.

(2) In order to bring more destructive fires against the enemy with its 165mm demolition projector, the CEV commander took down the locations of caves during the daylight hours and fired at them at night using a range card system. Three secondary explosions were achieved by using this method. Further damage assessment to enemy personnel or equipment was undeterminable because of the destructive power of the 165mm demolition projector. It was the only weapon available during the operation capable of destroying caves of the granite type found on Nui Ba Den.

(3) It was noticed that by placing a red filter on a flashlight and shining it in the direction to be observed by using a starlight scope that observation was made much easier because the red light aided in setting objects out more plainly and clearly.

CONFIDENTIAL

CONFIDENTIAL

(4) A starlight scope was used successfully with an M-119 periscope on occasion for spotting movement on the mountain at night.

f. The one advantage of the rocky terrain was that it offered overhead protection for US troops against "splash" from friendly supporting fires. However, the danger area of "splash" was increased two to three times because of indirect fire rounds impacting on the hard granite rocks. Not only shrapnel from the munitions endangered US forces, but also the debris caused by a splintering of the granite rocks. Because of the closeness of contact, supporting fires were at times brought within a very close distance from US forces on the mountain. Some US soldiers were wounded by this "splash".

4 Incl

- ~~1. Persons Being Interviewed~~
 - 2. Overlay - Phase I
 - 3. Overlay - Phase II
 - ~~4. Resupply to 3-22 Inf~~
- Incl 1 and 4 wd HQ, DA



RALPH J. BALLWAY
MAJ, INF
Division Historian

CONFIDENTIAL

CONFIDENTIAL

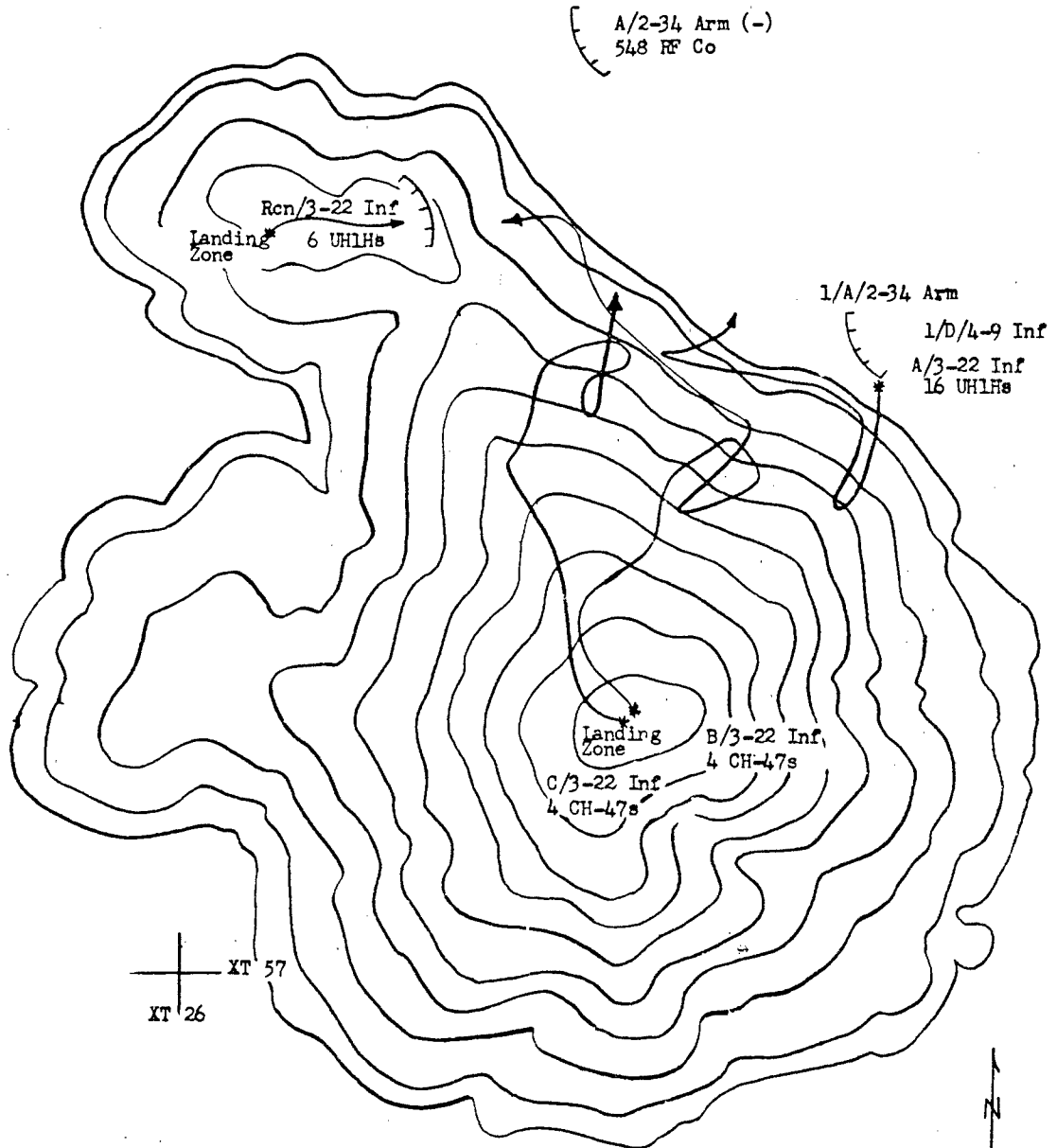

OPERATION CLIFF DWELLER IV

Inclosure 2 to Incl 11

PHASE I (4 - 8 January)
173

CONFIDENTIAL

~~CONFIDENTIAL~~

UNCLASSIFIED

A/2-34 Arm (-)
B/7-11 Arty (-)
B/3-22 Inf (-)

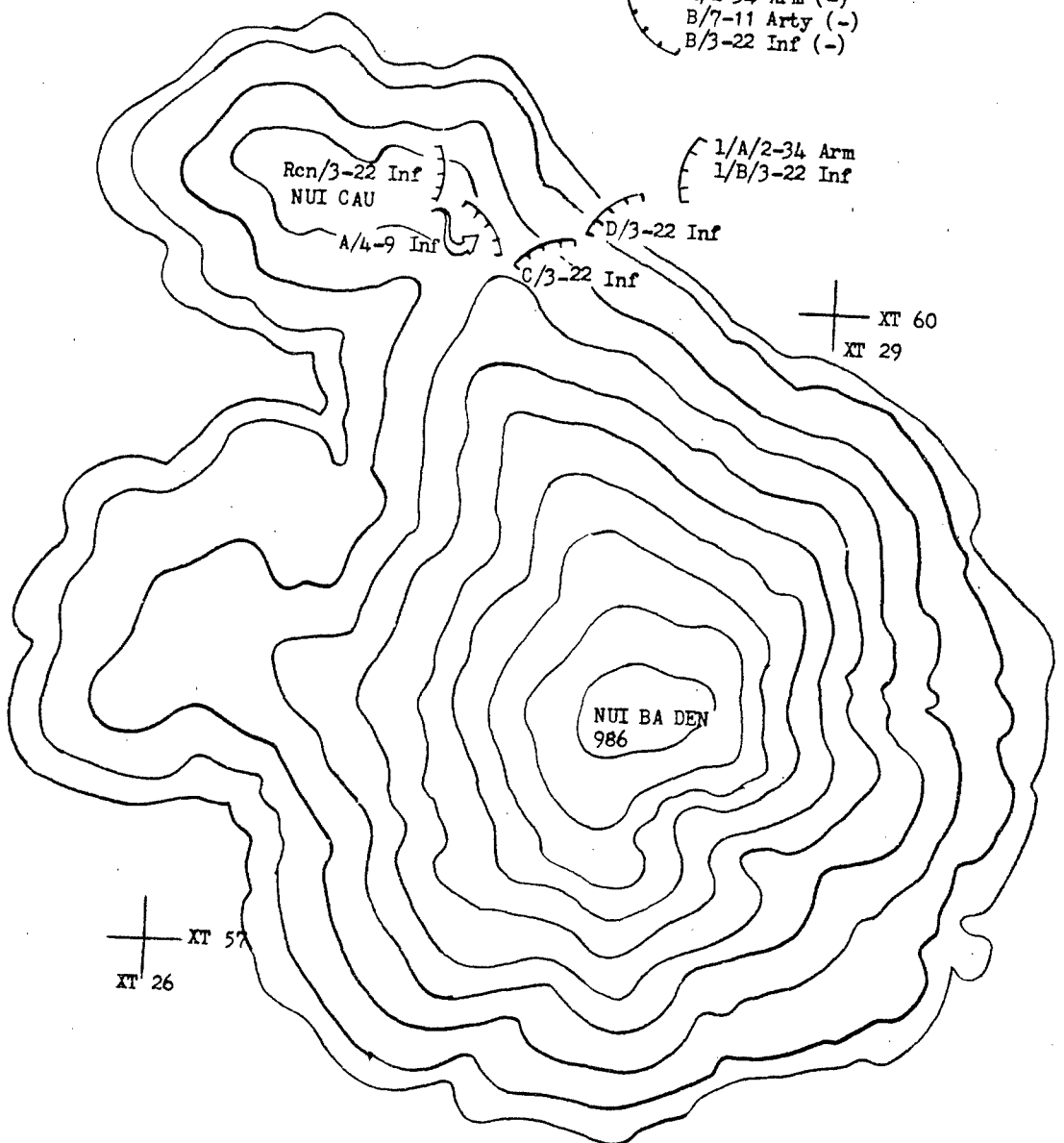

OPERATION CLIFF DWELLER IV
Inclosure 3 to Incl 11 PHASE II (9 - 11 January)

~~CONFIDENTIAL~~
174

UNCLASSIFIED

Best Available Copy

UNCLASSIFIED

Security Classification

DOCUMENT CONTROL DATA - R & D		
<small>(Security classification of title, body of abstract and indexing annotation must be entered when the overall report is classified)</small>		
1. ORIGINATING ACTIVITY (Corporate author) HQ, OACSFOR, DA, Washington, D.C. 20310		2a. REPORT SECURITY CLASSIFICATION CONFIDENTIAL
		2b. GROUP 4
3. REPORT TITLE Operational Report - Lessons Learned, HQ, 25th Infantry Division		
4. DESCRIPTIVE NOTES (Type of report and inclusive dates) Experiences of unit engaged in counterinsurgency operations, 1 Nov 69 to 31 Jan 70.		
5. AUTHOR(S) (First name, middle initial, last name) CG, 25th Infantry Division		
6. REPORT DATE 1 February 1970	7a. TOTAL NO. OF PAGES 178	7b. NO. OF REFS
8a. CONTRACT OR GRANT NO.	9a. ORIGINATOR'S REPORT NUMBER(S) 701223	
b. PROJECT NO. N/A	9b. OTHER REPORT NO(S) (Any other numbers that may be assigned this report)	
c.		
d.		
10. DISTRIBUTION STATEMENT		
11. SUPPLEMENTARY NOTES N/A	12. SPONSORING MILITARY ACTIVITY OACSFOR, DA, Washington, D.C. 20310	
13. ABSTRACT		
175		

DD FORM 1 NOV 68 1473

UNCLASSIFIED

Security Classification

Best Available Copy